

Shepard

EXHIBITOR SERVICE MANUAL

NGAUS General Conference & Exhibition

Huntington Place | Detroit, MI

August 24 - 26, 2024

I138120824

SHOW INFORMATION

NGAUS General Conference & Exhibition

I138120824

Huntington Place | Detroit, MI

August 24 - 26, 2024

Booth Package

Items provided in your booth, per exhibitor:

- 8' High Backwall Drape with 3' High Sidewall Drape
- 7" x 44" Cardstock Identification Sign

Floor covering is mandatory per the Show Organizers guidelines. Booth spaces without carpet on Friday, August 23 at 4:30PM will have it automatically installed at the exhibitor's expense.

Show Colors

Show Drape Color(s): Black

Aisle Carpet Color: Tuxedo

Exhibit Show Schedule

GENERAL EXHIBITOR MOVE-IN

Wednesday, August 21, 2024 · 2:00PM to 4:30PM

Thursday, August 22, 2024 · 8:30AM to 4:30PM

Friday, August 23, 2024 · 8:30AM to 4:30PM

EXHIBIT HOURS

Saturday, August 24, 2024 · 10:00AM to 5:00PM

Sunday, August 25, 2024 · 8:00AM to 5:00PM

Monday, August 26, 2024 · 8:00AM to 12:00PM

EXHIBITOR MOVE OUT

Monday, August 26, 2024 · 3:00PM to 11:00PM

Tuesday, August 27, 2024 · 8:00AM to 3:00PM

FREIGHT REROUTE BEGINS*

*All outbound carriers must be checked in by this time

Tuesday, August 27, 2024 | 3:00PM

IMPORTANT DEADLINES

Discount Price Deadline for Custom Shepard Rentals

Thursday, July 25, 2024

Exhibitor Appointed Contractor Notification Deadline

Thursday, July 25, 2024

First Day for Warehouse Deliveries Without a Surcharge

Thursday, July 25, 2024

Discount Price Deadline for Standard Shepard Orders

Saturday, August 3, 2024

Last Day for Warehouse Deliveries Without a Surcharge

Wednesday, August 14, 2024

Last Day for Warehouse Deliveries*

Monday, August 19, 2024

* Date indicated is last day freight can arrive to advanced warehouse with guarantee of delivery to booth for exhibitor move-in.

First Day Freight Can Arrive at Show Site

Wednesday, August 21, 2024 | 8:00AM

Shipping Addresses

ADVANCE WAREHOUSE SHIPMENT ADDRESS

Exhibiting Co. Name & Booth Number
NGAUS General Conference & Exhibition
SES c/o T Force c/o JW Cole and Sons
6500 Mt Elliott Ave
Detroit, MI 48211

Warehouse hours: Monday - Friday 8:00AM - 4:00PM

DIRECT TO SHOW SITE SHIPMENT ADDRESS

c/o Shepard Exposition Services
Exhibiting Co. Name & Booth Number
NGAUS General Conference & Exhibition
Huntington Place
1 Washington Boulevard
Detroit, MI 48226

NGAUS General Conference & Exhibition

Huntington Place | Detroit, MI

August 24 - 26, 2024

I138120824

ONLINE & DISCOUNT DEADLINE:* SATURDAY, AUGUST 3, 2024

Due to liability concerns and/or labor jurisdictions, exhibitors or their Exhibitor Appointed Contractors (EACs) may not operate any type of mechanical or powered equipment including forklifts, manual or electric pallet jacks, overhead lifts, etc.

Shepard Mailing Address

1531 Carroll Drive, NW
Atlanta, GA 30318
Phone: 404-720-8600
Email: orders@shepardes.com

Service Desk Hours *(subject to change)*

Wednesday, August 21, 2024 · 2:00PM to 4:30PM
Thursday, August 22, 2024 · 8:30AM to 4:30PM
Friday, August 23, 2024 · 8:30AM to 4:30PM
Saturday, August 24, 2024 · 10:00AM to 5:00PM
Sunday, August 25, 2024 · 8:00AM to 5:00PM
Monday, August 26, 2024 · 8:00AM to 11:00PM
Tuesday, August 27, 2024 · 8:00AM to 12:00PM

Exhibitor Move Out

Monday, August 26, 2024 · 3:00PM to 11:00PM
Tuesday, August 27, 2024 · 8:00AM to 3:00PM

Dismantle & Move Out Information

Shepard will begin returning empty containers and skids as soon as the aisle carpet is removed and/or plastic protection is installed on top of the floor. All exhibitor materials must be removed from the facility by **Tuesday, August 27, 2024 | 3:00PM.**

Any materials remaining in the hall will be rerouted or returned to Shepard's warehouse to await disposition at the exhibitor's expense.

To ensure all exhibitor materials are removed from the facility during the exhibitor move out, please have all carriers checked in with Shepard no later than **Tuesday, August 27, 2024 | 3:00PM.**

Post Show Paperwork & Labels

Our Customer Service Representatives will gladly assist you in preparing your outbound shipping labels, outbound Material Handling Authorization paperwork, and outbound shipping in advance. You may find these forms included in this exhibitor services catalog. An email with links to an online portal will also be sent to the exhibitor contact on record for the booth. Labels and paperwork will also be available on-site. Make sure your carrier knows your company name, booth number, and the carrier check in deadline.

Outbound Shipping

It is the responsibility of each exhibitor to arrange for transportation of booth materials after the event. Our Customer Service Representatives are available pre show, during the show, and during move out to assist you in arranging shipping through our official carrier Shepard Logistics. For peace of mind and easy set up, contact Shepard Logistics before the event for transportation services to and from the event. Shepard does not provide UPS, FED-EX, or other carrier specific labels. Exhibitors must schedule pick ups directly with all carriers as well as provide carrier specific shipping labels.

Pick Up Address

Huntington Place
1 Washington Boulevard
Detroit, MI 48226

UTILITY & ANCILLARY VENDORS

NGAUS General Conference & Exhibition

Huntington Place | Detroit, MI

I138120824

August 24 - 26, 2024

ELECTRICAL SERVICES

[Freeman](#)

PLUMBING

[Huntington Place](#)

AUDIO VISUAL (AV)

[Premier Creative Group](#)

BOOTH CLEANING

[Huntington Place](#)

CATERING

[Sodexo Live!](#)

INTERNET/WIFI

[Huntington Place](#)

SECURITY

[S.A.F.E. Management](#)

LEAD RETRIEVAL

[American Tradeshow Services](#)

MOVE OUT NOTICE

NGAUS General Conference & Exhibition

Huntington Place | Detroit, MI

August 24 - 26, 2024

I138120824

NGAUS General Conference & Exhibition Move Out Notice

The NGAUS General Conference & Exhibition will end at 12:00PM, on Monday, August 26, 2024. Please don't pack up your booth before 12:00PM for everyone's safety. Below are some general processes. Specific instructions will be emailed to you before move out begins.

Returning Empty Containers: Once the aisle carpet is removed and/or plastic protection is installed on top of the floor, Shepard will start returning empty containers and skids. Depending on the size of the event, this could take several hours. Please keep the aisles free of crates, boxes, and furnishings to speed up the process. For safety reasons, please don't go to the dock area or storage area to find your crates.

Exhibitor Move Out Schedule:

Monday, August 26, 2024 · 3:00PM to 11:00PM

Tuesday, August 27, 2024 · 8:00AM to 3:00PM

Outbound Paperwork Requirements: To ship out or load out any materials from the building, you must have a Shepard Outbound Material Handling Authorization form. Make sure to pay your balances in full with Shepard Exposition Services to receive the form. Once you're packed and ready to leave, fill out the form and return it to the Shepard Service Desk. Label your boxes and leave your shipments in your booth space.

Show Carrier: Shepard Logistics can take care of all your shipping needs. Go to the Shepard Service Center to make your shipping arrangements.

Outside Carriers: To make sure everything is removed from the venue during the exhibitor move out, all carriers must check in with Shepard no later than 3:00PM on Tuesday, August 27, 2024. If you're shipping via UPS or FEDEX, bring your own labels as Shepard can't provide them for you. Contact UPS or FEDEX to schedule your pickup. Any materials left in the hall and not claimed by your designated carrier by Tuesday, August 27, 2024 | 3:00PM, will be rerouted via the show carrier or returned to Shepard's warehouse to await disposition at your expense.

Reroute Schedule: If you're still in the venue after Tuesday, August 27, 2024 | 3:00PM, you may be charged labor wait fees if your booth move out process delays Shepard Operations. There's also a disposal fee for all bulk items (non-sweep-able) left on the show floor.

Abandoned Items: Any items or equipment left in booths without shipping labels after Tuesday, August 27, 2024 | 3:00PM may be thrown away. Shepard Exposition Services won't be responsible for any unattended items left on the show floor. If you don't have a complete Outbound Material Handling Authorization, your shipment will be returned to the warehouse or shipped to you via alternate carriers at your expense.

Pick Up Location:

Huntington Place

1 Washington Boulevard

Detroit, MI 48226

BUDGET BOOTH PACKAGE

NGAUS General Conference & Exhibition

I138120824

Huntington Place | Detroit, MI

August 24 - 26, 2024

ONLINE & DISCOUNT DEADLINE:* FRIDAY, AUGUST 2, 2024

A Budget and Time Friendly Solution!

Booth Package 10' x 10'

** No substitutions will be accepted.

Each Economy 10' x 10' booth package includes:



**1 - 6' (l) x 24" (w) x 30" (h)
Skirted Table**
(50046)

See Step 3 to choose your specific drape color.



2 - Upholstered Side Chairs
(50020)



1 - Wastebasket (50091)

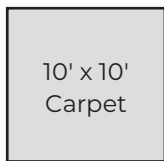

1 - 10' x 10' Carpet (50255)





See Step 2 to choose your specific carpet color.

Step 1. Tell us how many packages you want.









CODE	QTY	ONLINE	DISCOUNT	REGULAR
50260		\$788.35	\$906.60	\$1,015.40

* Order with complete Method of Payment must be received before Discount Deadline date to receive discounted pricing. Orders received after the discount deadline will no longer be package orders and will be placed for each individual item at the regular catalog rates.

Step 2. Choose your carpet color.

-  Red (01)
-  Burgundy (07)
-  Blue (05)
-  Tuxedo (50)
-  Black (06)

Step 3. Choose your table drape color.

-  Red (01)
-  White (03)
-  Grey (10)
-  Gold (04)
-  Teal (13)
-  Blue (05)
-  Green (02)
-  Black (06)
-  Burgundy (07)

TOTAL ESTIMATE	\$ _____
TAX (All tax rates are subject to change)	6.00%
AMOUNT DUE	\$ _____

Submission of this form indicates you read and accept the Payment Policy and Terms & Conditions. All orders canceled by the exhibitor within 30 days of first day of exhibitor move in day may be subject to cancellation fees up to 100% of the total order, based upon the status of move-in, work performed and/or Shepard set-up costs or expenses.

COMPANY NAME: _____ BOOTH NUMBER: _____

CONTACT NAME: _____

CONTACT EMAIL ADDRESS: _____



Email completed form to: orders@shepardes.com

shepardes.com

ONLINE ORDERING

IT'S EASY.

NGAUS General Conference & Exhibition

Huntington Place | Detroit, MI

I138120824

August 24 - 26, 2024

Order online through the Shepard Exhibitor Portal at

<https://apps.shepardes.com/olk/intro.asp>. Login or Create an Account and follow the simple instructions for ordering. If you need assistance during your shopping experience, contact us using our  chat feature on the right side of the screen. Representatives are available Monday - Friday, 8AM - 5PM EST.

1. Go to: <https://apps.shepardes.com/olk/intro.asp>
2. Select the Event.
3. Login from the Show Information page by clicking the  button.
4. Select your event, enter your email address and password then click Login.
User Name = **Your Email Address**
(provided by Event Management)
Password = **NGAUS24**
5. Don't have an account, click "Create an Account."
6. Once logged in, please confirm your profile information. If you need to update your information, please contact us at clientservices@shepardes.com.
7. To order, utilize the grey category drop-down menus above the Welcome message.
8. After making your selections, click the add to cart button on the bottom right of the page.
9. To view your order click the Shopping Cart Icon at the top right of the page.
10. Confirm your order, click and complete the payment process.

Login

If you are already registered for online ordering, please login below.

You'll need to select an event first. After you login you will have access to your other events as well.

Select an Event

Select a Show 

Email Address

youremail@yourcompany.com 

Password

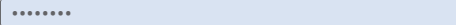
..... 

Login

[Forgot your password?](#)

Create an Account

Registration is easy. To create an account we need your email address, name, and company information.

Select an Event

Select a Show 

Creating an account will allow you to order online.

First, we will need your email address.

youremail@yourcompany.com 

METHOD OF PAYMENT

NGAUS General Conference & Exhibition

Huntington Place | Detroit, MI

I138120824

August 24 - 26, 2024

Please review the information and complete your payment information online.

You may choose to pay by credit card, check payable to Shepard Exposition Services, or bank wire transfer, however, we require your credit card authorization to be on file before we process your order(s) for service. **For your convenience, we will use your online credit card information to charge your credit card account for any additional amounts incurred as a result of show site orders placed by your representative including material handling and logistics charges for shipments received on your company's behalf and any unpaid balance due for Shepard services.** Credits for services will be issued at show site only.

Shepard no longer accepts cash payments for any Shepard Services. Once a payment is processed by credit card, any changes to the payment method will be charged a fee of 5% of the total invoice. 10010-Change Of Payment Method Transaction Fee.

Shepard Exposition Services only accepts payment information electronically. Place your order online with Shepard or follow the steps below to provide your payment information electronically and submit your order forms.

Complete your payment information online.

Log in to your account at <https://www.shepardes.com/payment-methods> and choose the event you are submitting payment for.

Discount Pricing Deadlines

Orders received without payment or after the discount price deadline will be charged at the standard price.

Online: Saturday, August 3, 2024 All paid orders placed online prior to the deadline date.

Discount Deadline: Saturday, August 3, 2024 All paid orders placed via pdf prior to the deadline date.

ACH/Wire Transfers

You may choose to pay by Check or ACH/Wire Transfer, however a credit card is required on file to process all orders.

Checks:

1. Checks can be mailed to: Accounts Receivable - 1778 Marietta Blvd, Atlanta, GA 30318

Wire Transfers:

1. Wire Transfers can be sent to bank information listed below.

2. **Important!** After your wire transfer has been sent, please send an email to ar-es@shepardes.com to confirm and include your show name, event code and your booth number. Unidentified payments can result in funds not being assigned to your account.

In order to accurately process the transfer of funds from your account, please complete the following information and email it along with a copy of the wire receipt to the email printed on the header of this page. A \$50 service charge will be added for processing checks drawn on foreign banks. A \$25 service charge will be added for processing U.S. wire transfers. \$50 service charge for international wire transfers.

The following information must be included on the bank copy of the wire transfer confirmation:

NAME OF SHOW BEING ATTENDED: **NGAUS General Conference & Exhibition**

EVENT CODE: **I138120824**

EXHIBITING COMPANY NAME: _____ BOOTH NUMBER: _____

Account Name: Shepard Exposition Services, Inc.	Routing Number: 041000124	SWIFT CODE (US): PNCCUS33	For Checks: Please include the show name, event code and your booth number on the check. For Wires: Please send payment sent confirmation email to ar-es@shepardes.com that includes the show name, event code and your booth number.
Bank Name: PNC Bank N.A., Pittsburgh, PA 15219 USA	Account Number: 42-6061-9772	SWIFT CODE (INTL): PNCCUS33	

TAX EXEMPT? Please submit tax exemption certificate to: orders@shepardes.com. If you are tax exempt, you must provide a tax exemption certificate for the state in which the event is being held.

TERMS & CONDITIONS

NGAUS General Conference & Exhibition

Huntington Place | Detroit, MI

I138120824

August 24 - 26, 2024

You are entering a contract which limits your possible recovery in case of loss or damage. The terms and conditions set forth below become a part of the contract between Shepard Exposition Services, and you, the Exhibitor.

Exhibitor is deemed to accept these terms and conditions when any of the following conditions are met:

Exhibitor materials are delivered to the Shepard warehouse or to a show or exposition site for which Shepard is the Official Show Contractor, or an order for labor and/or rental equipment is placed by the exhibitor with Shepard.

Definitions and Shepard Responsibilities: The name "Shepard" shall be construed within the meaning of this contract as Shepard Exposition Services, Inc. and its employees, officers, agents, and assigns including any subcontractors Shepard may appoint. The term "EXHIBITOR" refers to any party who contracts for services with Shepard. Shepard shall be responsible only for those services which it directly provides, and hereby agrees to execute its contracted duties in good faith. Shepard assumes no responsibility for any person, parties, or other contracting firms not under Shepard's direct supervision and control. Shepard shall not be responsible for loss, delay, or damage due to strikes, lockouts, work stoppages, natural elements, vandalism, acts of God, civil disturbances, power failures, acts of terrorism or war, or any other causes beyond Shepard's reasonable control; or for ordinary wear and tear in the handling of materials. Due to the security and liability requirements, Shepard personnel will unload all vendor materials from the loading docks to the booths. Exhibitors may not utilize powered mechanical equipment.

Indemnification: The exhibitor agrees to indemnify, forever hold harmless, and defend Shepard and its employees, officers and agents from and against any and all claims, causes of action, fines, penalties, damages, liabilities, judgments, and expenses on account of personal injury or death, damage to or loss of property or profits arising out of, or contributed to by any of the following: (1) exhibitor's negligent supervision of any labor secured through Shepard or the negligent supervision of such labor by any of the exhibitor's employees, agents, representative, invitees, and/or exhibitor appointed contractor (EAC); (2) exhibitor's negligence, willful misconduct, or deliberate act, or such actions of exhibitor's employees, agents, invitees, representatives, or EACs at the show to which this contract relates, including but not limited to the misuse, improper

use, unauthorized alteration, or negligent handling of Shepard equipment; or (3) exhibitor's violation of Federal, State, or Local ordinance; or violation of show regulations and/or rules as published by the Facility and/or Show Management.

Payments are due prior to delivery of services or equipment to EXHIBITOR unless other credit arrangements have been made. All payments shall be in U.S. currency, MasterCard, VISA, or American Express, debit cards, or check, provided there is sufficient customer credit in Exhibitor's form of payment to completely satisfy the amount owed by EXHIBITOR to Shepard. Undersigned authorizer acknowledges and agrees that all applicable charges for services rendered to the EXHIBITOR will be applied to the credit card on file in the event other form of payment is not tendered prior to the close of the trade show. In no instance shall any Exhibitor be extended credit beyond 30 days after the close of the Show. If there are any outstanding balances owed by EXHIBITOR to Shepard which have not been paid after 30 days following the close of the Show, then these unpaid balances shall bear interest at the rate of 1-1/2% per month (18% per annum). Exhibitor will be responsible for all charges incurred by Shepard while endeavoring to collect this account. If EXHIBITOR provides a credit card for payment and the credit card transaction is declined, EXHIBITOR hereby authorizes Shepard to process the outstanding balance in multiple smaller increments that total the amount of the outstanding payment obligation. In the event that a THIRD PARTY (AGENT) orders on behalf of the EXHIBITOR and the named THIRD PARTY does not discharge payment of the invoice prior to the last day of the show, charges will revert back to the EXHIBITOR. All invoices are due and payable upon receipt, by either party.

Show Site Orders: Services ordered at show site will require full payment at the time the order is placed. Purchase orders may not be used in lieu of payment. Regular prices will apply to all show site orders. Floor orders are limited to availability.

Third Party Orders: If you contract your work to a display or exhibit house and require services from Shepard, the payment policy stated above applies. Please pass this information on to them. A Third Party Payment form must be completed and submitted

three weeks prior to show opening. If your elected Third Party Provider fails to pay for Shepard Services, the exhibitor is still responsible for paying all invoices to Shepard.

Equipment Audits: EXHIBITOR should be advised that routine audits of Exhibitor booths for service usage are conducted during the Convention. Should the result of such an audit indicate that equipment or services is in fact being used that has not been paid for, the Exhibitor will be charged for the equipment or service at the applicable rate.

Exchanges and Cancellations: On-site exchanges and cancellations in orders will be assessed a 100% pick-up fee. Custom products: All orders canceled by the exhibitor within 30 days of first day of exhibitor move in day may be subject to cancellation fees up to 100% of the total order, based upon the status of move-in, work performed and/or Shepard set-up costs or expenses. Equipment and Furnishings: There are no exchanges or refunds once item has been delivered to your booth. Cancellations must be received in writing 14 days prior to first exhibitor move in day. Labor: Cancellations must be received in writing before 48 hours of 1st day of exhibitor move in, otherwise a 1 hour per man ordered will apply.

Invoices: Prior to close of show, an invoice will be prepared and emailed to the booth contact on file for your review. Credits will be issued at show site only. If you have any questions or want to pay your invoice by check or cash, please see our customer service representatives at the service desk on-site.

Outbound Services: All outbound services will be processed on your credit card. A copy of the receipt and invoice will be mailed within 10 days of the close of the show.

Rental Responsibility: All materials are on a rental basis and shall remain the property of Shepard. The customer shall be held financially responsible for any damage to Shepard equipment used by the customer. Prices quoted are for the duration of the show and include installation, rental, and removal except where indicated. If skirting and carpet colors are not selected, show colors will prevail.

continued on the next page

TERMS & CONDITIONS (continued)

NGAUS General Conference & Exhibition

Huntington Place | Detroit, MI

I138120824

August 24 - 26, 2024

International Customers: International customers must pay for all services in U.S. funds. A \$50 service charge will be added for processing checks or wire transfers drawn on foreign banks.

U.S. Wire Transfers: A \$25 service charge will be added for processing U.S. wire transfers. Please complete the wire transfer portion of the Method of Payment form. The credit card portion of the form must still be completed before your order will be processed.

Tax Exempt Status: If you are tax exempt in the state where the show is held, a copy of the certificate must accompany your order.

Tax Rates: State tax regulations and tax rates can change after the date of publication. Prevailing state tax rates will supersede any published rate.

Exhibitor Information: Exhibitor permits all contact information provided to Shepard to be used by Shepard and shared with other entities assisting in the production of the event in question. Facsimiles and email communications may include show information, promotional materials, advertising statements and other commercial notices. Permission may be revoked by the EXHIBITOR in writing.

Cancellation or Event Postponement: In the event the exposition or event is canceled or postponed, Shepard reserves the right to charge for services rendered in preparation of the event or exposition as well as non-refundable costs incurred by Shepard.

Insurance: It is understood that Shepard is not an insurer. Insurance should be obtained by the EXHIBITOR. It is highly recommended that exhibitors arrange All Risk coverage which usually can be done by endorsements to existing policies. Exhibitor's materials should be insured from the time they leave their firm until they are returned after the close of the show. Insurance and liability against theft or property damage to equipment or exhibit material owned or rented by EXHIBITOR, or bodily injury occurring within the confines of Exhibitor's booth, remain the sole and complete responsibility of EXHIBITOR. Except where prohibited by law, the EXHIBITOR and its insurers waive all rights of recovery or subrogation against Shepard and their respective directors, officers, employees, and agents.

Claim(s) for Loss and Payment For Services:

Exhibitor agrees that any and all claims for loss or damage shall be submitted to Shepard prior to the conclusion of the show when the alleged loss or damage occurred prior to that time, and in all cases within 30 days of the conclusion of the show. For claim reporting purposes, the "conclusion" of the show shall be construed as the end of the day on which exhibitor

must vacate the show site. All claims reported after the 30-day period will be rejected. In no event shall a suit or action be brought against Shepard more than one year after the date the loss or damage occurred. Payment for services may not be withheld. In the event of any dispute between Shepard and the exhibitor relative to any loss or damage claim, the exhibitor shall not be entitled to and shall not withhold payment for Shepard services as an offset against the amount of the alleged loss or damage. Any claim against Shepard shall be considered a separate transaction and shall be resolved on its own merit.

Limits of Liability: If found liable for any loss, Shepard's sole and exclusive maximum liability for loss or damage to Exhibitors materials and Exhibitor's sole and exclusive remedy is limited to \$.50 (USD) per pound per article with a maximum liability of \$100.00 (USD) per item, or \$1,500.00 (USD) per shipment whichever is less. All shipment weights are subject to correction and final charges determined by the actual or re-weighed weight of the shipment. Shepard shall in no event be liable for collateral, exemplary, indirect costs or damages, or loss of sales resulting from, or related to, a claim for loss of or damage to material.

Inbound and Outbound Shipments: Consistent with trade show industry practices, there may be a lapse of time between the delivery of shipment(s) to the booth and the arrival of the exhibitor or his representative. During such time, the materials will be left unattended. Shepard is not, and cannot be, responsible for loss, damage, theft, or disappearances of exhibitor's materials after same have been delivered to the exhibitor's booth. Similarly, there may be a lapse of time between the completion of packing and the actual pick up of exhibitor's materials from the booth for loading onto a carrier. During such time, the materials will be left unattended. Shepard shall not be responsible for loss, damage, theft, or disappearance of exhibitor's materials before same have been picked up for loading after the show. All materials will be checked at the booth at the time of loading using document(s) submitted by the exhibitor and notations of exceptions to conditions of materials or piece counts will be made on said document. Shepard assumes no responsibility for loss, damage, theft, or disappearance of exhibitor's materials after same have been delivered to exhibitor's appointed carrier or agent for transportation after the show. Shepard loads materials onto the carrier's truck under the supervision of the carrier driver who checks and signs for the materials. Shepard assumes no liability for any materials after the carrier assumes custody of materials. If exhibitor's designated carrier fails to show by the move out deadline after a show, Shepard shall have the authority to route exhibitor's shipment via an alternate carrier, or return shipment to a local warehouse for disposition at exhibitor's expense.

Packaging, Crates, and Empty Containers: Shepard shall not be responsible for surface damage to loose or uncrated materials, pad-wrapped, or shrink-wrapped materials. Shepard shall not be responsible for concealed damage, damage to carpets in bags or poly, or damage to materials improperly packed. Shepard shall not be responsible for crates and packaging unsuitable for handling, partially assembled, or having prior damage. Affixing "Empty" storage labels to containers is the sole responsibility of the exhibitor or their representative. All previous labels should be removed. Shepard assumes no responsibility for removal or mis delivery of containers with old labels or incorrect information on labels or for loss or damage to materials stored in containers labeled "empty."

THIRD PARTY PAYMENT

NGAUS General Conference & Exhibition

I138120824

Huntington Place | Detroit, MI

August 24 - 26, 2024

DEADLINE: THURSDAY, JULY 25, 2024

Return this form when a third party (any party other than exhibiting company) should be billed for services. Both parties **MUST** sign this form indicating acceptance; otherwise, request will be denied.

When a third party is handling your display and/or paying for any services on your behalf, we will agree to this third party arrangement if the following payment is agreed upon and all signatures are properly completed. By signing this form, both parties agree and understand that the exhibiting firm is responsible for all charges. **In the event that the named third party does not make payment by show close, Shepard will be paid by the exhibiting firm on demand at show site.** The show site invoice may or may not include any outbound services, such as additional material handling, rigging, and/or shipping charges.

Step 1. Provide the exhibiting company contact information and signature.

EXHIBITING COMPANY NAME: _____ BOOTH NUMBER: _____

EXHIBITING COMPANY ADDRESS: _____

CITY: _____ STATE: _____ ZIP CODE: _____

CONTACT EMAIL ADDRESS: _____ PHONE NUMBER: _____

EXHIBITING COMPANY AUTHORIZED NAME (please print): _____

SIGNATURE FROM EXHIBITING COMPANY: _____

Step 2. Check services below to bill to the third party.

- ALL SERVICES** Booth Cleaning Material Handling Carpet Furniture
 Exhibit Rentals Overhead Rigging/Labor Installation/Dismantling Labor Logistics/Transportation
Other (please specify): _____

Step 3. Provide third party contact information.

3RD PARTY COMPANY NAME: _____

CONTACT NAME: _____

EXHIBITING COMPANY ADDRESS: _____

CITY: _____ STATE: _____ ZIP CODE: _____

CONTACT EMAIL ADDRESS: _____ PHONE NUMBER: _____

SIGNATURE FROM THIRD PARTY COMPANY: _____

Step 4. Complete your payment information online.

Login to your account at <https://www.shepardes.com/payment-methods> and choose the event you are submitting payment for.

EXHIBITOR APPOINTED CONTRACTOR (EAC)

NGAUS General Conference & Exhibition

I138120824

Huntington Place | Detroit, MI

August 24 - 26, 2024

DEADLINE: THURSDAY, JULY 25, 2024

This form is to be completed by the Exhibitor and returned to Shepard by the deadline date noted above.

EXHIBITING COMPANY NAME: _____ BOOTH NUMBER: _____

CONTACT EMAIL ADDRESS: _____ PHONE NUMBER: _____

EXHIBITOR SIGNATURE: _____

An Exhibitor Appointed Contractor (EAC) is a company other than the "general or official" service provider on the show that requires access to your booth during installation and dismantling. The EAC may only provide services in the facility that are not designated by the facility as "exclusive" to a designated provider, or by the event organizer in a contract as an exclusive service for the "general or official" service provided or other third party.

No EAC will be allowed to work in an exhibitor's booth if this EAC form, a valid form of insurance, a third party Method of Payment form and an exhibitor Method of Payment is not completed by an authorized representative and received by Shepard by the due date indicated above. The Form must be completed for every third party (as well as any other ordering third party ordering or requesting services from Shepard on behalf of exhibitor) at the above event. Certificates of Insurance are to be uploaded [here](#). Multiple booths are not to be listed on one form. If form is not submitted by deadline date, the EAC will not be allowed to perform work in the hall except to supervise the official contractor provided labor.

EXHIBITOR APPOINTED CONTRACTOR: _____

CONTACT NAME: _____ PHONE NUMBER: _____

STREET ADDRESS: _____

CITY: _____ STATE: _____ ZIP CODE: _____

DESCRIPTION OF PROPOSED SERVICE FOR EXHIBITOR: _____

The EAC hired by the exhibitor must, by the deadline date, provide a current Certificate of Insurance with minimum limits of \$500,000 property damage per occurrence, \$1,000,000 personal injury per occurrence, workers compensation aggregate coverage of \$1,000,000 per occurrence, and naming Shepard Exposition Services as an additionally insured for the time period of the event, including move-in and move out days. If EAC does not have minimum coverage and proper documentation, they will be subject to employing Shepard Exposition Services for labor services. Certificates of Insurance are to be uploaded [here](#). If you need to order insurance, please click [here](#).

The EAC must abide by the rules and regulations of the show and all pertinent union regulations.

EAC employees must wear approved identification badges at all times while in the work area. Badge will be issued at show site to authorized contractor representatives when all requirements have been met.

The EAC must confine its operations to the exhibit area of its clients. No service desks, storage areas or other work facilities will be located anywhere in the facility. Show aisles and public areas are not part of the Exhibitor's booth space.

Solicitation of business by EAC is strictly prohibited. EAC companies discovered soliciting will be removed from the show floor and the exhibitor will not be able to use that EAC for the remainder of the event.

The EAC must have all business licenses, work permits and insurance required by State and City governments and Facility Management before beginning work, and shall provide Show Management with evidence of compliance.

If required, the EAC must be able to provide evidence that it has current and applicable labor contracts and must comply with all labor agreements and jurisdictions. The EAC must not jeopardize the production of the event by any act or practice that would lead to work stoppages, strikes or labor disputes.

EACs agrees to keep all No Freight Aisles clear at all times. If SES is required to rearrange any material situated in a clearly No Freight Aisle, the exhibitor or the EAC depending on billing arrangements will be a charged a 1 hour minimum forklift rental and labor.

TARGET INFORMATION

FIND YOUR TARGET DATE.

NGAUS General Conference & Exhibition

Huntington Place | Detroit, MI

I138120824

August 24 - 26, 2024

Review the target move in floor plan for your designated date and time. Confirm your Target date and time by submitting the Target Confirmation Form. If you need to request an alternate target date or time, submit the Target Change Request.

What is Targeting?

Targeting is the process of systematic freight delivery based on location of booths on a floorplan and exhibitor needs.

- A scheduled target time means that your freight will begin to be unloaded at some point during your allotted time frame.
- DO NOT schedule installation labor until after your scheduled target time.
- The best way to ensure your freight will be delivered to your booth during your scheduled time is to ship your freight to the Advance Warehouse.
- Machinery, uncrated items, oversized crates, and single pieces over the weight of 5,000 lbs. cannot be accepted at the advance warehouse and should be shipped directly to show site.

Shipping Labels

Shipping labels are included in this manual, please use them to help expedite handling.

Certified Weight Tickets

Certified weight tickets are required for all shipments.

Crated Shipments to the Advance Warehouse

Exhibitors who wish to have their crated material arrive at show site prior to or at their target date/time may do so by shipping in advance to the Shepard Advance Warehouse.

Shipments that arrive at the Advance Warehouse on or before **Monday, August 19, 2024** will be delivered to your booth prior to or during your assigned target date/time.

Shepard can not guarantee delivery of late warehouse freight received after **Monday, August 19, 2024** for delivery to your booth prior to or at your assigned target date/time.

Direct Shipments to Show Site

Targeted move-in dates/times have been assigned to all booths. Please refer to the target move-in floorplan included in this manual for your assigned target move-in date/time. All trucks delivering shipments to show site must check-in at the marshaling yard two hours prior to the assigned target date/time. The schedule is either 2 hours prior to the start of the target interval or 2 hours prior to the end of the target time; your presence is not required for unloading.

Off-Target Shipments

It is imperative that you adhere to the Target move-in schedule shown on the Target Floor Plan. All trucks delivering shipments to show site must arrive at the marshaling yard either 2 hours prior to the start of the target time. Trucks missing their target time will be unloaded on a first come, first serve basis after the trucks unloaded during their target time.

ALL trucks delivering to show site must check in at the marshaling yard for assignment of dock space. See Material Handling Authorization, Material Handling Information, Target Confirmation, and Material Handling 101 included in this manual.

Unloading

Priority unloading will be given to carriers who are targeted and checked in at the Marshaling Yard either 2 hours prior to the start of the target interval or 2 hours prior to the end of the target time. All others will be unloaded after "on-target" carriers are unloaded. Targeted shipments should be accessible on the truck and not blocked by non-targeted shipments or the non-targeted shipment may be considered off-target.

Shepard crews will make every possible effort to begin unloading carriers during their assigned target unload time.

TARGET CHANGE REQUEST

NGAUS General Conference & Exhibition

I138120824

Huntington Place | Detroit, MI

August 24 - 26, 2024

TARGET DEADLINE: FRIDAY, AUGUST 2, 2024

If you would like to request a change in your assigned target date/time, please complete and return this form. All requests will be reviewed and responded to within one week of received request.

Completion of this form does not automatically guarantee approval of request. We will attempt to honor all requests, but may not be able to grant all requests due to logistical considerations, booth locations, dock availability and labor demands.

All Target change requests must be received no later than:

Friday, August 2, 2024

Step 1. Complete company information.

COMPANY NAME: _____ BOOTH NUMBER: _____

CONTACT NAME: _____ PHONE NUMBER: _____

CONTACT EMAIL ADDRESS: _____ NUMBER OF TRUCKLOADS: _____

Where are you shipping?

Advanced Warehouse* Direct to Facility/Show Site

* Uncrated machinery, crated machinery over 5000 pounds, or machines requiring a flatbed truck will not be accepted at the advance warehouse. These items should be delivered directly to the facility on your designated target day and time.

Step 2. Provide target information.

CURRENTLY ASSIGNED DATE: _____ CURRENTLY ASSIGNED TIME: _____

REQUESTED DATE AND TIME: _____

REASON FOR CHANGE: _____



Email completed form to: targets@shepardes.com

shepardes.com

MARSHALING YARD INFORMATION

NGAUS General Conference & Exhibition

I138120824

Huntington Place | Detroit, MI

August 24 - 26, 2024

Show Site Address

Huntington Place
1 Washington Boulevard
Detroit, MI 48226

Marshaling Yard Address

640 Temple St.
Detroit, MI 48201

Map

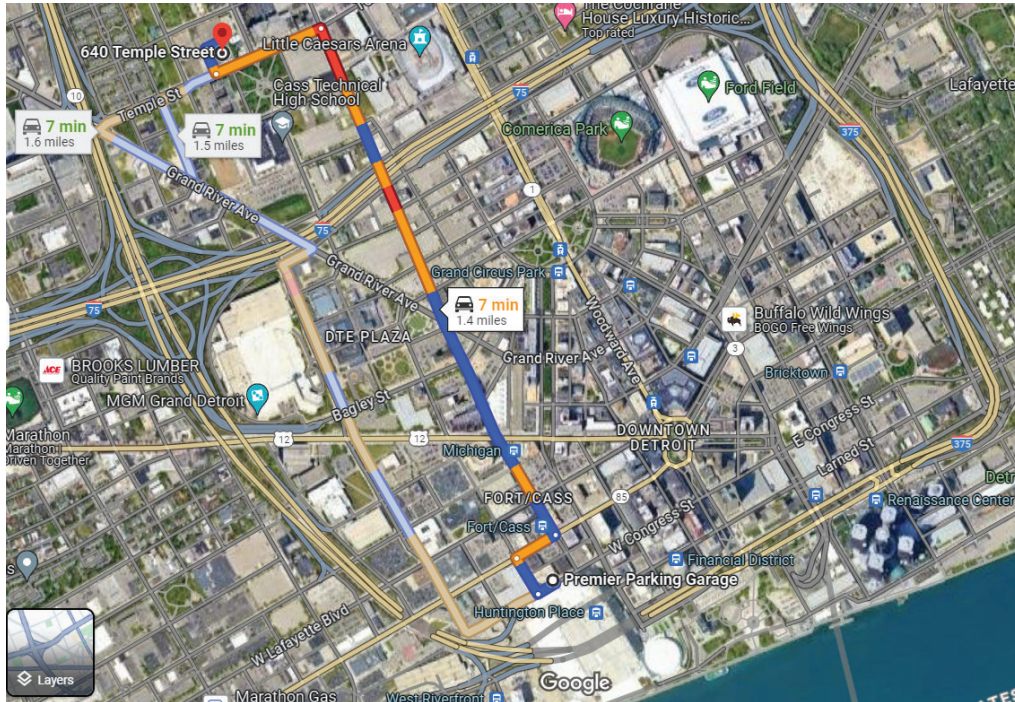

Marshaling Yard Hours of Operation

GENERAL MOVE IN

Tuesday, August 20, 2024
Wednesday, August 21, 2024
Thursday, August 22, 2024
Friday, August 23, 2024
Saturday, August 24, 2024

Yard Open

8:00AM
6:00AM
6:00AM
6:00AM
6:00AM

Receiving Cut Off

3:00PM
3:00PM
3:00PM
3:00PM
10:00AM

Yard Close

4:00PM
4:00PM
4:00PM
4:00PM
11:00AM

EXHIBITOR MOVE-OUT

Monday, August 26, 2024
Tuesday, August 27, 2024

Yard Open

10:00AM
5:30AM

Yard Close

9:00PM
2:00PM

ALL DRIVERS MUST BE CHECKED IN BY: Tuesday, August 27, 2024 | 12:00PM

SHIPPING VS. MATERIAL HANDLING

Make freight management easy.
With Shepard, You Can.



What is shipping?

Shipping is the process of a carrier picking up items from your office or any place of origin and transporting it to the dock of either the advance warehouse or event facility. Shipping is separate from Material Handling. Exhibitors may use any carrier they want, including Shepard Logistics.



What is material handling?

Material Handling is the process of receiving a shipment from your carrier and managing on-site handling of the shipment through the event cycle. It is a standard event procedure with associated costs typically based on shipment weight.

Material Handling Process:

- Unloading freight from your carrier once it arrives at the receiving dock.
- Transporting freight from dock to your booth space.
- Removing empty shipping containers (boxes, crates and pallets) from your booth.
- Temporarily storing your empty shipping containers during the show.
- Returning empty shipping containers to your booth at the close of event.
- Transferring your freight back to the loading dock.
- Loading your freight into your carrier's delivery vehicle for return shipping.

One easy way to keep charges low?

Consolidate. Whether you ship to the advance warehouse or directly to show site, it is in your best interest to consolidate your shipment as much as possible. Each shipment that arrives separately is assessed the minimum charge.

So, keep your charges low by skidding items so that they are sure to arrive together.

SHEPARD LOGISTICS

EFFICIENT. ON-TIME. GUARANTEED.

Enjoy convenience and confidence.
With Shepard Logistics, You Can.

Shepard Logistics is the official event carrier. Our dedicated team of logistics specialists will provide you with personalized and efficient shipping solutions to make sure your freight arrives on time.



Inbound & Outbound Services

- Standard ground
- 2-Day, and 3-Day service levels
- Air-ride
- Flatbed
- Dedicated truckload
- Volume discounts
- Caravan services

Material Handling



- Handle-with-care approach
- On-time delivery
- Fast resolution in case of damage
- Signature series material handling 10% discount to all round-trip customers



Value-Added Services

- Personalized service
- Priority empty return for all inbound with Shepard Logistics
- Transparent quotes with no hidden fees
- Available 7-days a week
- Late fees waived at Shepard events
- Outbound shrink wrap at no charge
- Shepard Logistics personnel on-site at your service for assistance

SHEPARD LOGISTICS SERVICES (SLS)

NGAUS General Conference & Exhibition

I138120824

Huntington Place | Detroit, MI

August 24 - 26, 2024

Ship Roundtrip with Shepard Logistics and receive a 10% discount on Material Handling*

*Discount does not apply to shipments considered small package, local deliveries, "Light Weight" shipments, or shipments over 10,000 lbs. Roundtrip SLS shipping is required to qualify for discount. (35572)

Shipping Services do not include Material Handling fees at Show Site. Material Handling fees will be charged to the credit card on file.

Step 1. Complete exhibiting company information.

EXHIBITING COMPANY NAME: _____ BOOTH NUMBER: _____

CONTACT NAME: _____ PHONE NUMBER: _____

CITY: _____ STATE: _____ ZIP CODE: _____

EMAIL ADDRESS: _____

Step 2. Where are we picking up the shipment?

COMPANY NAME: _____

STREET ADDRESS: _____ PHONE NUMBER: _____

CITY: _____ STATE: _____ ZIP CODE: _____

Is there a loading dock? Yes No

Is the building in a residential area? Yes No

Contact Name at residence: _____ Phone Number: _____

Do we need a lift gate on our truck? Yes No

Do we need to go inside your office to pick up your items? Yes No

Any thing else we should know about your building?

Step 3. When are we picking up the shipment?

DATE: _____ HOURS OF OPERATION: _____

Step 4. Where is the shipment going?

Advanced Warehouse Direct to Facility/Show Site

We recommend shipping to the Advance Warehouse to avoid wait times on show site.

Step 5. What are we shipping?

QTY	ITEM	LENGTH	WIDTH	HEIGHT	WEIGHT
	Crates				
	Cartons (cardboard)				
	Cases/Trunks				
	Skids/Pallets				

QTY	ITEM	LENGTH	WIDTH	HEIGHT	WEIGHT
	Carpet (color)				
	Monitors				
	Other				
TOTAL					

Step 6. What type of service is needed (how fast do you need it)?

Standard Ground 2nd Day Air Expedited Ground 3-5 days Other (Truckload, Specialized) _____

Service level may be changed to meet delivery date. Order must be received within 24 hours of requested pick up date. Expedited Ground (3-5) and air shipping available for pre-booked and confirmed orders only.

Step 7. After the event is over, are we shipping it back to you?

YES! No, I will arrange another carrier.

A credit card must be on file to order Shipping Services. Please complete the Method of Payment form. Shipping services do not include material handling charges at show site. Material handling fees will be charged to the credit card on file. For shipments coming out of or going to Canada, we must have a Commercial Invoice and your Custom Broker's contact information before we can finalize your shipment.

DSV Fairs & Events is the Preferred
International Freight Forwarder and
Customs Broker for Shepard events.

IMPORT ARRIVAL DEADLINE ESTIMATES:

LCL SEA FREIGHT – 5 weeks before the show opens

FCL SEA FREIGHT – 4 weeks before the show opens

AIR FREIGHT – 3 weeks before the show opens



OUR INTERNATIONAL SHIPPING SERVICES INCLUDE:

- Shipment planning - packaging, documentation, scheduling
- Pick-up and international shipping to the US air/port
- Customs clearance & delivery to the Shepard advance whse or show dock
- Pick-up at the show site dock or Shepard warehouse
- Export documents, international shipping and Customs clearance overseas
- Final delivery to the overseas return destination



Fairs & Events, Solutions USA
Contact: Kelly O'Neill-Exley
Product Specialist
Email: kelly.oneill@dsv.com
Main Office: + 1 786 577 6750
Mobile: +1 404 432 8835

Please contact us today
for a free quotation.

DSV Fairs & Events has an agent office in most countries worldwide. If you do not see your country listed below, then please contact DSV Fairs & Events USA, so that we can provide local contact details.

Canada

DSV Global Transport & Logistics
2200 Yukon Court
Milton, ON
L9E 1N5 Canada
Contact: Mohamad Alsayed
Tel: +1 905-203-2048
Mobile: +1 365 822 2333 (Faisal)
E-mail: fairs&eventsDSVcanada@ca.dsv.com

China

DSV Fairs & Events, Solutions
Rm 2307-2308, 23F
One Indigo
20 Jiuxianqiao Road
Chaoyang District
Beijing 10016
P.R. China
Contact: Roaddy Lu
Tel: + 86 10 8540 7288 / 7299
Mobile: + 86 13 91029 8808
Email: roaddy.lu@dsv.com

Denmark

DSV Solutions A/S
Fairs & Events
Center Boulevard 5
2300 Copenhagen S
Denmark
Contact: Lars Skovhoej
Tel: +45 43203859
Email: expo@dk.dsv.com

Germany

DSV Solutions GmbH
Fairs & Events
Gruener Deich 1
Hamburg 20097
Germany
Contact: Volker Baumann
Tel: + 49 41652189160
Mobile: + 49 1719793166
Email: volker.baumann@dsv.com

Hong Kong

DSV Fairs & Exhibitions
13001-11W, 103-04S&106-7S, 13/F
ATL Logistics Centre B, Berth 3
Kwai Chung Container Terminal NT
Hong Kong
Contact: Sunny Ling
Tel: + 852-2211 8205 / 8852 8205
Mobile: + 852 9622 3280
Email: sunny.ling@dsv.com

Italy

DSV Solutions SRL
Fairs and Events
Via Dante 134
20096 Pioltello, Milan Italy
Contact: Marco Simone
Tel: + 39 02 921 34036
Mobile: + 39 342 7410283
Email: marco.simone@dsv.com

Japan

DSV Fairs & Events, Solutions
Imperial Hotel Tower 16F 16A-4
1-1-1 Uchisaiwaicho, Chiyoda-ku
Tokyo 100-0011
Japan
Contact: Shingo Kobayashi
Tel + 81 3 4565 4569
Mobile: + 81 80 2478 9133
Email: JP.FE@dsv.com

Korea

DSV Fairs & Events, Solutions
Magok Central Tower 1 Cha, 227
Gonghang-daero
Gangseo-gu, Seoul,
07802
Korea
Contact: Chris Lim
Tel: + 82 2 2192 7420
Mobile: +82 10 2800 1834
Email: chris.lim@dsv.com

Portugal

DSV Transitários, Lda
Rua Abade Correia da Serra, 112
Senhora da Hora,
4460-208
Portugal
Contact: Silvia Eloi
Tel: + 351 266 088 642
Mobile: + 351 916 141 569
E-mail: silvia.eloi@dsv.com

Singapore

DSV Solutions Pte Ltd
No.5
Changi North Way
5th Floor, 498771
Singapore
Contacts: Maybelline Oun
Tel: + 65 6500 5610
Mobile: + +65 9655 3031
Email: maybelline.oun@dsv.com

Spain

DSV Fairs & Events, Solutions
Pol. Ind. Riera del Molí
Les Licorelles, Calle A num. 1
08750 Molins de Rei
Barcelona
Spain
Contact: Belina Flores
Tel: + 930 260 838
Mobile: + 34 34 686 902 300
Email: belina.flores.sierra@dsv.com

Taiwan

DSV – Translink Fairs & Events
Room 5-2, 5th Floor
No. 99, Chung Shan N. Rd
Sec 2., Taipei 104-48
Taiwan R.O.C.
Contact: Frances Lin
Tel: + 886 2 2581 1133
Fax: + 886 2 2523 9449
Email: frances@trans-link.com.tw

Turkey

DSV Fairs & Events
Rüzgarlıbahçe Mahallesi
Cumhuriyet Caddesi
Acarlar İş Merkezi C Blok No:10
34805 Beykoz İstanbul Turkey
Contact: Tandogan Ozman
Tel: + 90 216 680 16 00
Mobile: + 90 533 938 04 55
Email: tandogan.ozman@dsv.com

United Arab Emirates

DSV Fairs & Events, Solutions
Level 15, Office No. 07-08
Sheikh Rashid Tower
Dubai World Trade Centre
P.O.Box 36683, Dubai, UAE
Contact: Nilofer Sayeed
Tel: + 971 4 813 1487 / 813 1210
Mobile: + 971 56 6833914
Email: nilofer.sayeed@dsv.com

United Kingdom

DSV Fairs & Events, Solutions
One Western Gateway
Royal Victoria Dock
London E16 1XL, United Kingdom
Contact: Garcia Newell
Tel: + 44 207 069 5321
Mobile: + 44 7760 165828
Email: garcia.newell@dsv.com

DSV Fairs & Events, Solutions USA

Contact: Kelly O'Neill-Exley
Product Specialist
Email: kelly.oneill@dsv.com

Main Office: + 1 786 577 6750

Mobile: +1 404 432 8835

www.dsv.com

OUTBOUND MATERIAL HANDLING AUTHORIZATION & LABEL REQUEST

NGAUS General Conference & Exhibition

I138120824

Huntington Place | Detroit, MI

August 24 - 26, 2024

All outbound shipments require a Shepard Outbound Material Handling Authorization (MHA) form and shipping labels. Shepard offers complimentary pre-printing of these items. To take advantage of this service, please complete this request and submit to Shepard. Your pre-printed MHA and labels will be delivered to your booth prior to the close of the show.

Note: All third parties must pick up MHA/labels at the Shepard Service Desk.

**\$\$\$\$\$
SAVING TIP!**

Use Shepard Logistics for inbound and outbound and receive a discount on your Material Handling fees!

Step 1. Complete exhibiting company information.

EXHIBITING COMPANY NAME: _____ BOOTH NUMBER: _____

CONTACT NAME: _____ PHONE NUMBER: _____

EMAIL ADDRESS: _____

Step 2. Where is the shipment going?

COMPANY NAME: _____ BUSINESS HOURS: _____

STREET ADDRESS: _____

CITY: _____ STATE: _____ ZIP CODE: _____

Step 3. How many pieces are in your shipment?

OF CRATES: _____ # OF SKIDS: _____ # OF CASES: _____ # OF CARTONS: _____ APPROX. TOTAL WEIGHT: _____

Step 4. What are we shipping?

QTY	ITEM	LENGTH	WIDTH	HEIGHT	WEIGHT
	Crates				
	Cartons (cardboard)				
	Cases/Trunks				
	Skids/Pallets				

Is there a loading dock? Yes No

Is the building in a residential area? Yes No

Residential contact name _____ Phone Number _____

Do we need a lift gate on our truck? Yes No

Do we need to go inside your office to deliver your items? Yes No

Step 5. How many labels do you need? _____

Step 6. Who is picking up your shipment?

Official Show Carrier: SHEPARD LOGISTICS Other (Truckload, Specialized) _____

If selecting a carrier other than Shepard Logistics, you must schedule the pickup. This includes Fed Ex, UPS, etc. If using FedEx or UPS you must have and apply their shipping labels.

Step 7. What type of service is needed (how fast do you need it)?

Ground 2nd Day Expedited Ground (3-5 Days) Overnight For Shepard Logistics customers, Expedited and Air shipments are available for pre-booked orders only.

Step 8. What do we do with your items if your carrier doesn't show up?

Send out via Shepard Logistics or available carrier Return to warehouse for pickup, \$1,500 minimum charge per shipment

In order to process your order, we require payment on file. Please complete the Method of Payment and return to Shepard Exposition Services.

If you have already placed an order with Shepard, we will automatically use the credit card on file for your company. For shipments going into or out of Canada, we must have the Commercial Invoice and the Custom Brokers contact information before we can finalize your shipment.



Email completed form to: orders@shepardes.com

shepardes.com

ADVANCED SHIPPING LABEL

NGAUS General Conference & Exhibition

I138120824

Huntington Place | Detroit, MI

August 24 - 26, 2024

Print at least one shipping label for each box. Include the exhibiting company name and booth number. If you are creating your own labels, make sure the same information below is on your labels.

ADVANCED WAREHOUSE	 Shepard
	ADVANCED WAREHOUSE
RUSH	TO:
	_____ (Exhibiting Company Name)
	_____ (Exhibiting Company Booth Number)
	SES c/o T Force c/o JW Cole and Sons 6500 Mt Elliott Ave Detroit, MI 48211
	FOR: NGAUS General Conference & Exhibition
	_____ Delivery Hours: Monday - Friday 8:00AM - 4:00PM First day freight can arrive without a surcharge: Thursday, July 25, 2024 Last day freight can arrive without a surcharge: Wednesday, August 14, 2024

DIRECT SHIPPING LABEL

NGAUS General Conference & Exhibition

I138120824

Huntington Place | Detroit, MI

August 24 - 26, 2024

Print at least one shipping label for each box. Include the exhibiting company name and booth number. If you are creating your own labels, make sure the same information below is on your labels.

DIRECT TO SHOW SITE	 Shepard
	DIRECT TO SHOW SITE
RUSH	TO:

	(Exhibiting Company Name)

	(Exhibiting Company Booth Number)
	c/o Shepard Exposition Services Huntington Place 1 Washington Boulevard Detroit, MI 48226
	FOR: NGAUS General Conference & Exhibition
	MUST NOT BE DELIVERED PRIOR TO: Wednesday, August 21, 2024 8:00AM

ALL INCLUSIVE MATERIAL HANDLING RATES

NGAUS General Conference & Exhibition

I138120824

Huntington Place | Detroit, MI

August 24 - 26, 2024

Ship Roundtrip with Shepard Logistics and receive a 10% discount* on Material Handling

* Discount does not apply to shipments under 100 lbs. or shipments over 10,000 lbs. and local deliveries. Roundtrip SLS shipping is required to qualify for discount. (35572)

What is Material Handling? Material Handling is the unloading and delivery of exhibit freight to the exhibitor's booth on the show floor, the storage of empty containers, the return to booth for packing, and the loading back onto the exhibitor's outbound carrier. This is an automatic service and is billed based on weight. This service, whether used completely or in are part, are billed as a package.

Per Pound Material Handling Rates All rates are per one pound. There is no minimum charge. Certified weight tickets are required on all shipments. The rates stated are blended to include overtime based on the schedule at publication. Changes in schedule or if your carrier delivers your freight outside of these hours may result in additional fees.

How to Calculate Material Handling Services Material handling, whether used completely or in part are offered as a round trip service. The weight on your certified weight ticket is the amount you will be charged X the per pound material handling rate.

Advanced Warehouse Shipments**

** Single pieces over 5000 pounds, machines or uncrated items cannot be accepted at warehouse.

FIRST DAY FREIGHT CAN ARRIVE: Thursday, July 25, 2024
LAST DAY FREIGHT CAN ARRIVE: Monday, August 19, 2024

CODE	ITEM	WEIGHT	PRICE/LB.	TOTAL
35786	Crated ONLY		\$2.22	

X

Direct to Facility/Show Site Shipments***

*** Large pieces of machinery and uncrated shipments can be accepted at show site.

FIRST DAY FREIGHT CAN ARRIVE: Wednesday, August 21, 2024

CODE	ITEM	WEIGHT	PRICE/LB.	TOTAL
35785	Crated		\$2.22	
35285	Uncrated		\$2.22	

X

X

Other Material Handling Services

CODE	ITEM	WEIGHT	PRICE	TOTAL
35490	Banding Service Per 4x4 Skid/Pallet		\$75.00	
35491	Shrink-wrap Service Per 4x4 Skid/Pallet		\$75.00	

X

X

TOTAL ESTIMATE	\$ _____
TAX (All tax rates are subject to change)	6.00%
AMOUNT DUE	\$ _____

Only Shepard personnel are allowed to operate mechanical equipment. We understand that your calculation is only an estimate. Invoicing will be calculated from actual certified weight ticket or reweigh ticket on inbound material handling receiving report. Adjustments will be made accordingly. Any adjustments to charges must be made at show site. Acceptance of said terms and conditions will be construed when any of the following conditions are met: This Material Handling Agreement (MHA) is signed; Exhibitor's materials are delivered to Shepard's warehouse or to an event site for which Shepard is the Official Show Contractor or an order for labor and/or rental equipment is placed by Exhibitor with Shepard. Please be aware that disposal of exhibit properties is not included as part of your material handling charges. Please contact Shepard for your quoted rates and rules applicable to disposal of your exhibit properties. **All Material Handling charges are billable and will be charged to the credit card on file.**

COMPANY NAME: _____ BOOTH NUMBER: _____

CONTACT NAME: _____

EMAIL ADDRESS: _____



Email completed form to: orders@shepardes.com

ALL INCLUSIVE MATERIAL HANDLING

Shepard Exposition Services is the sole provider of Material Handling Services. Exhibitors or their hired EAC/Carriers may not deliver freight to exhibit spaces or operate any type of mechanical or powered equipment.

Special Handling Definitions

This is included in your per pound rate.

Shipments received that are packed in a manner as to require additional handling/labor are deemed special handling. Examples of shipments falling into this category would be constricted space unloading, ground unloading, stacked shipments, designated piece unloading, shipment integrity, mixed shipments, no bill of lading or documentation, carpet/pad only shipments.

Constricted Space

Freight packed in trailer to full capacity. Shipments are not easily accessible because trailer is loaded by cubic space, or top to bottom and side to side.

Stacked Shipments

Shipments with multiple pieces stacked on top of one another throughout the majority of the truck or trailer requiring unstacking during the unloading process.

Mixed Shipments

Mixed shipments are shipments that contain a mixture of uncrated and crated materials, and the uncrated portion is minimal deeming the shipment special handling but not uncrated. But in cases where greater than 50% of the load by volume is uncrated the load will be categorized as uncrated.

Shipment Integrity

Shipments loaded on a carrier in a manner requiring separating or sorting to reestablish the integrity of each shipment.

Carpet/Pad Only

Carpet and/or pad only shipments are time and labor intensive, and require additional manpower and tools (e.g. carpet poles, flatbed carts or scooters, dollies).

No Documentation

Shipments received from small package carriers (including, among others, Fed Ex, UPS, & DHL) that are delivered without documentation or bills of lading that require additional sorting, processing, and tools for delivery.

Designated Piece Unloading

Shipments loaded in such a manner that require the unloading/loading crew to be directed by driver remove items in a particular order, or unloading and reloading items to reach certain pieces behind others remaining on the trailer.

Padded Van Deliveries

This applies to van line carriers that transport freight at cubic displacement rates, operate a non-standard dock height equipment, require freight on the truck to be unloaded in a specific order or orientation, or require that freight on the truck be moved to unload the actual delivery.

Disposal Fee

A disposal fee & minimum 1 hr. labor will be charged for all booth materials (booth displays, flooring, etc.) that are left unclaimed after show move out.

Overtime/Double-time

This is included in your per pound rate.

SURCHARGE: Overtime: 30% • Double Time: 50%
Shipments that are moved and/or handled on overtime and/or double time hours will incur a surcharge based on the handling times noted on the receiving/shipping documents. Drivers picking up outbound shipments will be sequenced for loading ONLY after a bill of lading is submitted to the Shepard Service Desk AND the driver has checked in.

Warehouse Overtime/Double-time

This is included in your per pound rate.

SURCHARGE: Overtime: 30% • Double Time: 50%
Advanced shipments may be received during straight time hours at the warehouse location, however an overtime/double time surcharge may be applied to an advanced warehouse shipment due to required delivery schedule based on show move-in and move out hours beyond our control. This would also be true if freight was received after hours at the warehouse trapping facility.

Early/Late Shipments to the Warehouse

SURCHARGE: 25% • 35003

A surcharge will apply to shipments not arriving within the published dates (refer to Show Information page for dates) for advance warehouse or arriving on show site after show opening. Any shipment arriving to show site after show open will be charged a surcharge.

Uncrated Shipments

This is included in your per pound rate.

Rate as shown on Material Handling Rate Form

An additional charge of 50% (or as stated on Material Handling Authorization page) of the applicable material handling charge at the time of delivery shall be charged for all loose, uncrated, or unprotected shipments received at the show site docks. The charge is a one-time charge that includes both move-in and move out of the show, and is based on the weight of the shipment handled.

Off-Target Deliveries

SURCHARGE:

15% • 35004

For targeted shows (exhibitors who received/requested a Targeted Date/Time), a surcharge will apply if shipment is not delivered (or carrier has not checked in) during assigned target date/time.

Marshaling Yard

This is included in your per pound rate.

FEE:

\$30 per Shipment • 35250

Where Shepard Exposition Services as the show contractor must lease space for Marshaling Yard operations because no space is provided by the facility, Shepard may charge a one time fee per shipment processed inbound and/or outbound through the Marshaling Yard.

Reweigh of Shipments

This is included in your per pound rate.

FEE:

\$25.00 per forklift load • 35282

An additional charge per forklift load will be applied to shipments that have to be reweighed at the dock due to the lack of a certified weight ticket, or an incorrect or understated weight on a delivery document.

Empty Crate Storage

FEE:

\$25.00 per piece • 35105

A charge per crate, carton or skid applies when Shepard handles the storage and return of empties from a shipment not received by Shepard and therefore not subject to material handling charges.

Envelope Deliveries

FEE:

\$10.50 per envelope • 35007

During show hours at the show facility, a charge will apply to receiving and delivering envelope packages to your booth.

Priority Empty Labels

FEE:

\$150.00 per label • 35064

Limited quantities available on a per event basis.

Mobile Spotting

FEE:

\$200 per round trip

All vehicles must be escorted in and out of building by Shepard personnel.

ALL INCLUSIVE MATERIAL HANDLING

Shepard Exposition Services is the sole provider of Material Handling Services. Exhibitors or their hired EAC/Carriers may not deliver freight to exhibit spaces or operate any type of mechanical or powered equipment. Material handling is a billable service.

What is material handling (also referred to as drayage)? Material handling is the process of unloading your freight from your shipping carrier, either at the warehouse or show site, delivering it to your booth, storing your empty containers (empties) if required, returning of your empties at the close of show, and then reloading your freight back onto your shipping carrier.

What is the definition of "freight"? Any exhibit materials shipped or delivered to the advance warehouse or show facility via shipping carrier, POV, or delivery truck.

What is the difference between material handling and shipping? Shipping is the process of transporting your shipment from its origin to its final destination. Material handling begins at the time your shipment arrives to the docks (please refer to "What is material handling?" for the full definition.) These are 2 different items and are billed differently.

Do I need to order a forklift to unload or reload my freight? No, please do not order a forklift for unloading/reloading of your materials.

What does CWT mean?
(does not apply to All Inclusive Rates)
CWT is an acronym for Century Weight.

What determines how much I'm charged? Charges are based on certified inbound weight ticket included with your shipment as well as the type of service required.

How do I calculate material handling charges? Material handling, whether used completely or in part are offered as a round trip service.

CWT Calculation:
When recording weight, round up to the next 100 lbs.
EXAMPLE: 285 lbs. = 300 lbs./100 lbs. = 3 X RATE = \$ Amount or minimum charge, whichever is greater.

All Inclusive Calculation:
EXAMPLE: 285 lbs. = 285 x RATE = \$

Will there be any additional charges? Additional charges may apply. Please review the Material Handling Authorization and Material Handling Additional Services forms included in the manual for all applicable fees.

What are Light Weight shipments?
(does not apply to All Inclusive Rates)

All shipments regardless of carrier that weigh 40 pounds or less. Shipments need to have certified weight tickets or other verifiable weight noted upon delivery. Shipments without certified weight tickets may be subject to special handling or reweigh fees. Packages that arrive separately at different times or days will be billed separately.

All shipments, regardless of carrier, weighing 41 lbs. and up will be billed using the standard material handling rates listed in the kit and billed at a 200 lb. minimum.

How do I calculate my Light Weight shipment?

(does not apply to All Inclusive Rates)
Charges for Light Weight shipments are total shipment weight, per delivery. Any shipment above 40 lbs. will not qualify for this rate. Please be advised that your whole shipment may not arrive to its destination at one time. Therefore you may be charged per each delivery.

What are Crated Materials? Materials delivered that are skidded or in a container that can easily be unloaded/reloaded with no additional handling required.

What are Uncrated Materials? Materials delivered that are loose, pad-wrapped or unskidded without proper lifting bars and/or hooks.

What is Special Handling?

(does not apply to All Inclusive Rates)
Shipments received that are packed in a manner as to require additional handling/labor are deemed special handling. Examples of shipments falling into this category would be constricted space unloading, ground unloading, stacked shipments, designated piece unloading, shipment integrity, mixed shipments, no bill of lading or documentation, carpet/pad only shipments.

What are Advanced Shipments? All shipments that are addressed to the advance warehouse address (please refer to "Advance Warehouse" shipping labels included in this manual). Shepard will begin accepting your shipments 30 days prior to first show open day (date may vary depending on show schedule).

The warehouse will receive shipments Monday-Friday, 8:00 AM - 4:00 PM, excluding holidays. Shipments must arrive by advanced warehouse deadline date to avoid late surcharge. (Please refer to the "Show Information" page included with this manual for deadline date.)

Crates, cartons, skids, fiber cases, and carpets can be accepted at the warehouse, but DO NOT ship crates weighing over 5,000 lbs., loose/uncrated shipments and/or machinery to warehouse. You must ship those items direct to show site.

All shipments must have a bill of lading or delivery slip indicating number of pieces and weight. Certified weight tickets required.

All shipments must be prepaid, no collect on delivery shipments will be accepted.

What are Direct Shipments? All shipments that are addressed directly to the exhibit facility (please refer to "Direct to Show" shipping labels included in this manual).

Shipments must arrive during published exhibitor move-in times only. Do not ship direct to show site in advance. If delivery cannot be guaranteed to arrive during exhibitor move-in, shipment must go to advance warehouse.

All shipments must have a bill of lading or delivery slip indicating number of pieces and weight. Certified weight tickets required.

Crates weighing over 5,000 lbs. or loose/uncrated shipments must be shipped direct to show site to arrive during exhibitor move-in times.

All shipments must be prepaid, no collect on delivery shipments will be accepted.

What is and why would I need liability insurance?

Accidents happen, therefore, most show organizers and facilities require liability insurance. Please refer to your booth contract for exact minimums required.

Please make sure your materials are covered from the moment they leave your company location to the time they return after the close of the show.

If applicable, included in your manual is information and an application for liability insurance and booth coverage can also be purchased to protect your valuable exhibit materials.

Outbound Shipping You must complete a Shepard Material Handling Agreement (MHA) for all outbound shipments. A MHA will be distributed at show site if all services have been paid in full, or you can request one at the customer service desk.

Upon completion of packing and labeling of your materials, complete the bill of lading (MHA) with all required information, and return to the customer service desk. If you have questions on how to complete your bill of lading (MHA), please ask a Shepard customer service representative located at the customer service desk.

If you are NOT using the designated show carrier, you must call your carrier with pick-up information. If your carrier fails to pick up your shipment, Shepard Logistics will either reroute your freight through the carrier of our choice or return to the local warehouse (whichever is indicated on your MHA).

Equipment. Exhibitors or their EACs may not utilize or operate any type of material handling mechanical or powered equipment. If you need assistance, please contact us to order labor and equipment.

MACHINE RATES

NGAUS General Conference & Exhibition

I138120824

Huntington Place | Detroit, MI

August 24 - 26, 2024

This is for MACHINERY only. For all other shipments, please refer to the Material Handling Rates page. Uncrated machinery and machines over 5,000 pounds cannot be accepted at the warehouse. All uncrated machinery and 5,000 pound machine shipments should be delivered directly to the facility during move-in or on your designated target day and time. Machines do not qualify for per pound pricing.

Important Things to Know!

- Use of these specially discounted rates are for your **machinery shipments only**.*
* All other freight will be billed at standard Material Handling Rates.
- Certified weight tickets** are required for all shipments.
- Mixed load shipments** without separate weight tickets do not qualify for the machinery rates and will be invoiced at the regular material handling rate. Adjustments will not be made.
- When shipping a mixed load, **separate weight tickets** are required to distinguish between machinery and exhibit materials.
- All shipments must have proper inbound Bill of Lading or carrier bill with **weight breakdowns**.

For all machine shipments, Shepard will do the following:

- Receive shipments consigned directly to the facility on installation days.
- Deliver your machine to your booth.
- Remove and store your empty containers.
- Return your empty containers to your booth.
- Load your outbound shipment on your carrier of choice.

Labor Hours

Straight Time (ST): Monday - Friday | 8:00AM - 4:00PM

Overtime (OT):

Monday - Friday | 4:00PM - Midnight. Saturday 8:00AM - Midnight.

Double Time (DT): Monday - Saturday | Midnight - 8:00AM. All hours Sunday. Holidays.

Holidays: New Years Day, Memorial Day, Independence Day, Labor Day, Thanksgiving, Christmas. If a holiday falls on a Sunday it will be observed on Monday.
*These Holidays only apply in certain cities.

Overtime: 30% fee for each overtime application based on ST rate
Double Time: 50% fee for each double time application based on ST rate

CODE	ITEM DESCRIPTION	WEIGHT	PER CWT RATE
35992	2,501 - 5,000 lbs.		\$55.40
35993	5,001 - 10,000 lbs.		\$50.40
35994	10,001 - 20,000 lbs.		\$47.85
35995	20,001 - 30,000 lbs.		\$45.35
35996	30,001 + lbs.		\$43.70

35586	Special Handling** 2,501 - 5,000 lbs.		\$72.00
35587	Special Handling** 5,001 - 10,000 lbs.		\$65.50
35588	Special Handling** 10,001 - 20,000 lbs.		\$62.20
35589	Special Handling** 20,001 - 30,000 lbs.		\$58.95
35590	Special Handling** 30,001 + lbs.		\$56.80

**A special handling rate is charged for extra labor or equipment required to unload or load machinery when it cannot be unloaded or loaded with a forklift in a normal manner. Examples of material handling requirements warranting special handling charges are: Rigging equipment on or off of a truck using jacks, chains, rollers, skates, straps, or cables; the use of multiple forklifts due to the length of the machinery or the lack of lifting points on the machinery, or due to the type of vehicle transporting the machinery.

TOTAL ESTIMATE	\$ _____
TAX (All tax rates are subject to change)	6.00%

Only Shepard personnel are allowed to operate mechanical equipment. We understand that your calculation is only an estimate. Invoicing will be calculated from actual certified weight ticket or reweigh ticket on inbound material handling receiving report. Adjustments will be made accordingly. Any adjustments to charges must be made at show site. Acceptance of said terms and conditions will be construed when any of the following conditions are met: This Material Handling Agreement (MHA) is signed; Exhibitor's materials are delivered to Shepard's warehouse or to an event site for which Shepard is the Official Show Contractor or an order for labor and/or rental equipment is placed by Exhibitor with Shepard. Please be aware that disposal of exhibit properties is not included as part of your material handling charges. Please contact Shepard for your quoted rates and rules applicable to disposal of your exhibit properties. **All Material Handling charges are billable and will be charged to the credit card on file.**

COMPANY NAME: _____ BOOTH NUMBER: _____

CONTACT NAME: _____

EMAIL ADDRESS: _____



Email completed form to: orders@shepardes.com

MACHINE SHIPPING INFORMATION REQUEST

NGAUS General Conference & Exhibition
Huntington Place | Detroit, MI
August 24 - 26, 2024

I138120824

FORM & MACHINE DIAGRAMS DEADLINE: THURSDAY, JULY 25, 2024

In order to ensure your machinery is properly handled and to avoid delays during set up, please provide the following information on your machines.

Step 1. How many machines are you shipping?

QUANTITY OF MACHINES: _____

Step 8. Where are the pick points located on your machine?

Top Bottom

Step 2. What is the weight of each machine?

1: _____ 2: _____ 3: _____ 4: _____
5: _____ 6: _____ 7: _____ 8: _____

Step 9. What is the weight per square foot* of each machine?

1: _____ 2: _____ 3: _____ 4: _____
5: _____ 6: _____ 7: _____ 8: _____

* 350 pounds per sq. ft. is the maximum allowed for this convention center. If you exceed this weight rating you must provide steel plating in order to disperse the weight.

Step 3. What are the dimensions of each machine?

1: _____ 2: _____ 3: _____ 4: _____
5: _____ 6: _____ 7: _____ 8: _____

Step 10. Please attach any photos or diagrams you have of your machines.

Photos Attached No Photos

Step 5. How is your machine being shipped?

Flatbed Close Trailer Container

Step 6. Do you need special equipment to unload?

Extended Forklift Blades Rollers Slings
 Other _____

Step 7. Do you require a forklift in your booth space to unskid, assemble, or spot machinery?

Yes No

Only Shepard personnel are allowed to operate mechanical equipment. We understand that your calculation is only an estimate. Invoicing will be calculated from actual certified weight ticket or reweigh ticket on inbound material handling receiving report. Adjustments will be made accordingly. Any adjustments to charges must be made at show site. Acceptance of said terms and conditions will be construed when any of the following conditions are met: This Material Handling Agreement (MHA) is signed; Exhibitor's materials are delivered to Shepard's warehouse or to an event site for which Shepard is the Official Show Contractor or an order for labor and/or rental equipment is placed by Exhibitor with Shepard. Please be aware that disposal of exhibit properties is not included as part of your material handling charges. Please contact Shepard for your quoted rates and rules applicable to disposal of your exhibit properties. **All Material Handling charges are billable and will be charged to the credit card on file.**

COMPANY NAME: _____ BOOTH NUMBER: _____

CONTACT NAME: _____

EMAIL ADDRESS: _____



Email completed form to: targets@shepardes.com

shepardes.com

MACHINERY ADVANCED SHIPPING LABEL

NGAUS General Conference & Exhibition

I138120824

Huntington Place | Detroit, MI

August 24 - 26, 2024

This label is for is for MACHINERY only. For all other shipments, please use the standard shipping labels. **Uncrated machinery and machines over 5,000 pounds cannot be accepted at the warehouse. All uncrated machinery and 5,000 pound machine shipments should be delivered directly to the facility** during move-in or on your designated target day and time

Print at least one shipping label for each machine. Include the exhibiting company name and booth number. If you are creating your own labels, make sure the same information below is on your labels.

ADVANCED WAREHOUSE	 ADVANCED WAREHOUSE- MACHINERY SHIPMENT
	TO: <hr/> <small>(Exhibiting Company Name)</small> <hr/> <small>(Exhibiting Company Booth Number)</small> SES c/o T Force c/o JW Cole and Sons 6500 Mt Elliott Ave Detroit, MI 48211
RUSH	FOR: NGAUS General Conference & Exhibition
	<hr/> Delivery Hours: Monday - Friday 8:00AM - 4:00PM First day freight can arrive without a surcharge: Thursday, July 25, 2024 Last day freight can arrive without a surcharge: Wednesday, August 14, 2024

MACHINERY DIRECT SHIPPING LABEL

NGAUS General Conference & Exhibition

I138120824

Huntington Place | Detroit, MI

August 24 - 26, 2024

This label is for is for MACHINERY only. For all other shipments, please use the standard shipping labels. **Uncrated machinery and machines over 5,000 pounds cannot be accepted at the warehouse. All uncrated machinery and 5,000 pound machine shipments should be delivered directly to the facility** during move-in or on your designated target day and time

Print at least one shipping label for each machine. Include the exhibiting company name and booth number. If you are creating your own labels, make sure the same information below is on your labels.

DIRECT TO SHOW SITE	 Shepard
	DIRECT TO SHOW SITE - MACHINERY RATES
RUSH	TO:
	_____ (Exhibiting Company Name)
	_____ (Exhibiting Company Booth Number)
	c/o Shepard Exposition Services Huntington Place 1 Washington Boulevard Detroit, MI 48226
	FOR: NGAUS General Conference & Exhibition
	MUST NOT BE DELIVERED PRIOR TO: Wednesday, August 21, 2024 8:00AM

CARTLOAD SERVICE

NGAUS General Conference & Exhibition

I138120824

Huntington Place | Detroit, MI

August 24 - 26, 2024



Cartload Service provides service to exhibitors arriving in personally owned vehicles (POVs) and have small hand-carried items that need to be delivered to and from the dock/booth location. Exhibitors may not utilize mechanical or powered equipment to unload their items.

Cartload Service includes:

Includes:

- **One laborer**
- **One cart**
- **One trip** (per rate listed below)

Please remember:

- If you arrive with a truck, van, trailer, or truck with trailer filled with exhibit material you will not qualify for this service and will be redirected.
- No personal trucks (one (1) ton & over), no rental trucks, trailers, or bobtails will be unloaded through cartload service.
- All items must fit on flat bed cart (approximately 3' x 4' in size) and weigh less than 200 pounds. If items are designated by Shepard personnel to be too large or too heavy, materials will be billed at regular material handling rates.
- Your vehicle must unload on the receiving dock of the exhibit hall. Shepard personnel will direct vehicles. The cart is not authorized to enter or go to any parking structure. There must be two (2) people with the vehicle; one person to go with your product to the booth space and one person to remove your vehicle from the unloading area to the parking area.

Labor Hours

Straight Time (ST): Monday - Friday | 8:00AM - 4:00PM.

Overtime (OT): Monday - Friday | 4:00PM - Midnight. Saturday 8:00AM - Midnight.

Double Time (DT): Monday - Saturday | Midnight - 8:00AM. All hours Sunday.

Holidays:

New Years Day, Memorial Day, Independence Day, Labor Day, Thanksgiving, Christmas. If a holiday falls on a Sunday it will be observed on Monday.

**These Holidays only apply in certain cities.*

CODE	ITEM	# OF TRIPS	RATE	TOTAL
35151	Dock to Booth ST		\$255.00	
35152	Booth to Dock ST		\$255.00	
35153	Dock to Booth OT		\$362.50	
35154	Booth to Dock OT		\$362.50	

TOTAL ESTIMATE	\$ _____
TAX (All tax rates are subject to change)	6.00%

Only Shepard personnel are allowed to operate mechanical equipment. No refunds or exchanges once service has been rendered. Cancellations must be received in writing within 48 hours of first day of exhibitor move in.

COMPANY NAME: _____ BOOTH NUMBER: _____

CONTACT NAME: _____

EMAIL ADDRESS: _____



Email completed form to: orders@shepardes.com

VEHICLE REQUEST FORM

NGAUS General Conference & Exhibition

I138120824

Huntington Place | Detroit, MI

August 24 - 26, 2024

If you wish to display a vehicle in your booth at NGAUS General Conference & Exhibition, please fill out the form below and return to orders@shepardes.com.

Make sure you review details about the Mobile Spotting Fee section of the Exhibitor Services Manual.

Important Rules and Regulations:

- Battery Cables must be disconnected.
- Gas Cap must either be taped shut or have a lockable gas cap.
- Must contain less than 1/4 tank of gas.
- Exhibitor is responsible for checking local Fire Marshal rules and regulations for additional requirements.

Exhibitor Information

COMPANY NAME: _____ BOOTH NUMBER: _____

CONTACT NAME: _____ PHONE: _____

EMAIL ADDRESS: _____

STREET ADDRESS: _____

CITY: _____ STATE: _____ ZIP: _____ COUNTRY: _____

VEHICLE INFORMATION (MAKE, MODEL, YEAR, COLOR, ETC.): _____

ARRIVAL DATE: _____

ARRIVAL TIME: _____

MOBILE SPOTTING FEE

NGAUS General Conference & Exhibition

I138120824

Huntington Place | Detroit, MI

August 24 - 26, 2024

Displaying a Vehicle at the Event?

(including rolling stock, self-propelled, towed and/or pushed vehicles/machinery)

All vehicles must be escorted on and off the floor by a Shepard representative. Shepard charges a round-trip fee, per vehicle, to place a vehicle on the trade show floor. Additional charges may apply when additional labor and equipment are required.

Step 1.

If you have a vehicle, make sure it is shown on the official floorplan by alerting Customer Service or your Event Management.

Step 2.

Contact Customer Service to schedule your move in and out. Vehicle placement must be supervised by the exhibitor.

Important Rules and Regulations

- Battery Cables must be disconnected.
- Gas Cap must either be taped shut or have a lockable gas cap.
- Must contain less than 1/4 tank of gas.
- Exhibitor is responsible for checking local Fire Marshal rules and regulations for additional requirements.

All vehicles must be removed no later than:

Tuesday, August 27, 2024 | 12:00PM

Any vehicles left after that time are subject to removal by towing or other means. Exhibitors are responsible for all removal charges.

CODE	ITEM	QTY	RATE	TOTAL
35106	Motorized Unit/Vehicle Spotting		\$200.00	

Additional fees may apply if mobile spot cannot be driven into place and must be assisted or if scheduled mobile spot time is missed.

TOTAL ESTIMATE	\$ _____
TAX <i>(All tax rates are subject to change)</i>	6.00%
AMOUNT DUE	\$ _____

No refunds or exchanges once service has been rendered. Cancellations must be received in writing 48 hours prior to first day of exhibitor move in.

COMPANY NAME: _____ BOOTH NUMBER: _____

CONTACT NAME: _____

EMAIL ADDRESS: _____



Email completed form to: orders@shepardes.com

shepardes.com

PERSONALLY OPERATED VEHICLE (POV) UNLOADING INFORMATION

Shepard Exposition Services has the responsibility of receiving and handling all the exhibit materials and empty crates that come in via over the road carriers. It is Shepard's responsibility to manage the docks and schedule vehicles for the smooth and efficient move-in and move out of the exhibition. Shepard will not be responsible for any materials they do not handle.

Vehicles:



✓ **ALLOWED POVs INCLUDE:**

- Passenger Automobile
- Mini Van
- SUV
- Pick-up Truck



These vehicles shown to the left are considered POVs and will be allowed to unload/load in the designated POV ramp area after checking in at the marshaling yard.



NOT ALLOWED IN THE DOCK AREA:

- × Trailers of any kind
- × No Step Van/Box Truck
- × Full Size Vans



The vehicles shown to the left are considered rental trucks and trailers and will not be allowed access to the dock spaces to self unload/load.



Vehicles like shown at the left will be unloaded by dock personnel and not by exhibitors.

Equipment and Materials:



Exhibitors may not operate or utilize any type of powered and mechanical equipment. See examples to the left of equipment that can and cannot be used.



✓ **ALLOWED:**

- Hand Carried Boxes



NOT ALLOWED:

- × 2-wheel or 4-wheel Hand Carts
- × Pallet Jacks

Please refer to the *Labor Rules and Regulations* page for additional information and guidelines.

FORKLIFTS & GROUND RIGGING

NGAUS General Conference & Exhibition

I138120824

Huntington Place | Detroit, MI

August 24 - 26, 2024

DISCOUNT DEADLINE:* FRIDAY, AUGUST 2, 2024

* Order with complete Method of Payment must be received before Discount Deadline date to receive discounted pricing.

Labor Hours

Straight Time (ST):

Monday - Friday | 8:00AM - 4:00PM.

Overtime (OT):

Monday - Friday | 4:00PM - 8:00AM. All hours on Saturday.

Double Time (DT):

All hours on Sunday. Holidays.

Holidays:

New Years Day, Memorial Day, Independence Day, Labor Day, Thanksgiving, Christmas.

*These Holidays only apply in certain cities.

Step 1: Describe the work.

Uncrating Materials Spotting Equipment Booth Work/Ground Rigging

Will you need: Straps Extended Blades Weight of Heaviest Piece: _____

Step 2. When are we moving it?

(times are not guaranteed)

Install Date/Time: _____

Dismantle Date/Time: _____

Step 3. Choose your lift size.

FORKLIFT RENTAL - UP TO 5,000 LB. CAPACITY						
CODE	ITEM	EST. # OF HOURS	ONLINE	DISCOUNT	REGULAR	TOTAL
35028	ST Hourly Rental		\$345.00	\$396.75	\$444.35	
35039	OT Hourly Rental		\$533.15	\$613.10	\$686.65	
35067	DT Hourly Rental		\$667.50	\$767.60	\$859.70	

FORKLIFT RENTAL - UP TO 10,000 LB. CAPACITY						
CODE	ITEM	EST. # OF HOURS	ONLINE	DISCOUNT	REGULAR	TOTAL
35029	ST Hourly Rental		\$690.00	\$793.50	\$888.70	
35049	OT Hourly Rental		\$1,066.25	\$1,226.20	\$1,373.35	
35069	DT Hourly Rental		\$1,335.00	\$1,535.25	\$1,719.50	

FORKLIFT RENTAL - UP TO 15,000 LB. CAPACITY						
CODE	ITEM	EST. # OF HOURS	ONLINE	DISCOUNT	REGULAR	TOTAL
35455	ST Hourly Rental		\$862.50	\$991.85	\$1,110.85	
35456	OT Hourly Rental		\$1,332.80	\$1,532.70	\$1,716.60	
35457	DT Hourly Rental		\$1,668.75	\$1,919.05	\$2,149.35	

FORKLIFT RENTAL - UP TO 20,000 LB. CAPACITY						
CODE	ITEM	EST. # OF HOURS	ONLINE	DISCOUNT	REGULAR	TOTAL
35035	ST Hourly Rental		\$1,035.00	\$1,190.25	\$1,333.10	
35066	OT Hourly Rental		\$1,599.40	\$1,839.30	\$2,060.00	
35070	DT Hourly Rental		\$2,002.50	\$2,302.90	\$2,579.25	

Only Shepard personnel are allowed to operate mechanical equipment. Orders canceled without 48-hour written notice will be charged a one (1) hour cancellation fee. Submission of this form indicates you read and accept the Payment Policy and Terms & Conditions.

COMPANY NAME: _____ BOOTH NUMBER: _____

CONTACT NAME: _____

EMAIL ADDRESS: _____



Email completed form to: orders@shepardes.com

shepardes.com

FORKLIFT RENTAL - UP TO 30,000 LB. CAPACITY						
CODE	ITEM	EST. # OF HOURS	ONLINE	DISCOUNT	REGULAR	TOTAL
35255	ST Hourly Rental		\$1,380.00	\$1,587.00	\$1,777.45	
35256	OT Hourly Rental		\$2,132.50	\$2,452.40	\$2,746.70	
35257	DT Hourly Rental		\$2,670.00	\$3,070.50	\$3,438.95	

FORKLIFT RENTAL - 4 STAGE						
CODE	ITEM	EST. # OF HOURS	ONLINE	DISCOUNT	REGULAR	TOTAL
35593	ST Hourly Rental		\$517.50	\$595.15	\$666.55	
35594	OT Hourly Rental		\$799.70	\$919.65	\$1,030.00	
35595	DT Hourly Rental		\$1,001.25	\$1,151.45	\$1,289.60	

IN BOOTH SCISSOR LIFTS						
CODE	ITEM	EST. # OF HOURS	ONLINE	DISCOUNT	REGULAR	TOTAL
68120	Scissor Lift Install		\$807.00	\$928.05	\$1,039.40	
68121	Scissor Lift Removal		\$807.00	\$928.05	\$1,039.40	

Rate structure includes forklift and one (1) operator only. Minimum crews are based on scope of work and area jurisdiction. Additional labor and groundmen will be billed at the hourly rate. **PLEASE NOTE:** Per riggers jurisdiction, a rigging crew (up to 3 riggers) may require a 4-hour minimum to install any hanging sign, truss and/or motors, or structures requiring hoisting. Rates are per lift and crew per hour.

GROUND RIGGING SUPERVISOR RATES (PER MAN HOUR)						
CODE	ITEM	EST. # OF HOURS	ONLINE	DISCOUNT	REGULAR	TOTAL
35085	ST Hourly Rental		\$268.75	\$309.05	\$346.15	
35086	OT Hourly Rental		\$403.13	\$463.60	\$519.25	
35099	DT Hourly Rental		\$537.50	\$618.15	\$692.35	

GROUND RIGGERS & MATERIAL HANDLERS (PER MAN HOUR)						
CODE	ITEM	EST. # OF HOURS	ONLINE	DISCOUNT	REGULAR	TOTAL
35087	ST Hourly Rental		\$215.00	\$247.25	\$276.90	
35100	OT Hourly Rental		\$322.50	\$370.85	\$415.35	
35101	DT Hourly Rental		\$430.00	\$494.50	\$553.85	

The minimum charge for labor and equipment is one (1) hour. Labor and equipment thereafter is charged in half (1/2) hour increments.

TOTAL ESTIMATE	\$ _____
TAX (All tax rates are subject to change)	6.00%
AMOUNT DUE	\$ _____

ON-SITE STORAGE

NGAUS General Conference & Exhibition

I138120824

Huntington Place | Detroit, MI

August 24 - 26, 2024

On-site Storage is used when you have product you need to replenish during the event, or if you have items you don't want stored with the empty crates. Do not use this service for "Empty" storage. Two different types of storage are available:

Accessible Storage: Use this type when you need to pull items out of storage during the show. Materials in Accessible Storage will be accessible during the event, but not necessarily by exhibitors. The charge for Accessible Storage is a daily storage fee plus a per hour labor fee each time materials are moved.

Secured Storage: Use this type only if you do not need your items again until the end of the event. Materials will be placed into secured storage and will be returned to your booth after the close of the show. The materials will be accessible during the show by Shepard personnel only. A minimum one-hour material handling labor charge at show rates will apply each time material is handled to or from storage.

Step 1. Complete exhibiting company information.

EXHIBITING COMPANY NAME: _____ BOOTH NUMBER: _____

ON-SITE CONTACT NAME: _____ ON-SITE CELL PHONE: _____

For liability reasons, only shipments for which material handling drayage charges have been paid to Shepard will be eligible for Shepard storage services. All packages must be properly packed & labeled. Shepard Exposition Services' limit of liability will be \$5.00 per pound or \$500.00 per package or container, whichever is less. No uncrated material will be accepted at the warehouse.

Step 2. Choose the type of storage to fit your needs.

For either storage options, there is no charge to return items back to your booth at the end of the event.

Accessible Storage

STEP 1:

CODE	ITEM	QTY		COST PER DAY		NUMBER OF DAYS		EST TOTAL 1
35166	Pallets/Skids		X	\$35.00	X		=	
35349	1/2 Trailer		X	\$80.00	X		=	
35348	Full Trailer		X	\$120.00	X		=	

STEP 2:

CODE	ITEM	COST PER MOVE		NUMBER OF MOVES		EST TOTAL 2
35087	Labor - Straight Time	\$215.00	X		=	
35100	Labor - Overtime	\$322.50	X		=	
35101	Labor - Double Time	\$430.00	X		=	

STEP 3: Add your Estimated Total from Step 1 to the Estimated Total of Step 2.

EST TOTAL 1	+	EST TOTAL 2	=	EST STORAGE TOTAL

Secure Storage

STEP 1:

CODE	COST PER SQ. FT.		EST SQ. FT. NEEDED		NUMBER OF DAYS		EST TOTAL 1
35068	.80	X		X		=	

STEP 2:

CODE	ITEM	COST PER MOVE		NUMBER OF MOVES		EST TOTAL 2
35087	Labor - Straight Time	\$215.00	X		=	
35100	Labor - Overtime	\$322.50	X		=	
35101	Labor - Double Time	\$430.00	X		=	

STEP 3: Add your Estimated Total from Step 1 to the Estimated Total of Step 2.

EST TOTAL 1	+	EST TOTAL 2	=	EST STORAGE TOTAL

Only Shepard personnel are allowed to operate mechanical equipment. No refunds or exchanges once item has been delivered to your booth. Cancellations must be received in writing within 48 hours of 1st day of exhibitor move in. Submission of this form indicates you read and accept the Payment Policy and Terms & Conditions.

COMPANY NAME: _____ BOOTH NUMBER: _____

CONTACT NAME: _____

EMAIL ADDRESS: _____



Email completed form to: orders@shepardes.com

WAREHOUSE STORAGE

NGAUS General Conference & Exhibition

I138120824

Huntington Place | Detroit, MI

August 24 - 26, 2024

Warehouse Storage is used when you need a place to store your exhibit or product for days, weeks, or even until your next event.

Pricing

- Warehouse storage rates are billed \$10.00 per cwt per month (\$100.00 a month minimum charge) (35006).
- Each shipment returned to the warehouse for storage will be billed \$20.00 per cwt (\$400.00 minimum) (35005).
- For liability reasons, only shipments for which material handling drayage charges have been paid to Shepard will be eligible for Shepard storage services.
- All packages must be properly packed & labeled. Shepard Exposition Services' limit of liability will be \$5.00 per pound or \$500.00 per package or container, whichever is less. No uncrated material will be accepted at the warehouse.

Step 1. Complete exhibiting company information.

EXHIBITING COMPANY NAME: _____ BOOTH NUMBER: _____

ON-SITE CONTACT NAME: _____ ON-SITE CELL PHONE: _____

EMAIL ADDRESS: _____

Step 2. What needs to be stored?

TOTAL NUMBER OF PIECES TO BE STORED: _____

PIECE	LENGTH	WIDTH	HEIGHT	WEIGHT	CRATE/SKID
1					
2					
3					
4					
5					
6					

PIECE	LENGTH	WIDTH	HEIGHT	WEIGHT	CRATE/SKID
7					
8					
9					
10					
11					
12					

TOTAL ESTIMATE \$ _____

TAX (All tax rates are subject to change) 6.00%

AMOUNT DUE \$ _____

Step 3. How long are we storing your items?

FROM DATE: _____ TO DATE: _____

Fees will continue until storage is picked up.

Step 4. What do we do with your items at the end of the storage period?

It is the exhibitor's responsibility to make all arrangements for shipping, including utilizing Shepard Logistics. Items **WILL NOT** automatically be taken to the next event. Exhibitor should contact Shepard approximately 2 weeks prior to any storage movement.

 Ship to another destination via Shepard Logistics* Transport to another Shepard event*

*Additional fees will apply

 Pick-up is arranged with another carrier: _____

Submission of this form indicates you read and accept the Payment Policy and Terms & Conditions. Storage Items will not be stored or released without a valid credit card on file.

PRINTED NAME: _____

Email completed form to: orders@shepardes.com
shepardes.com

SHEPARD FURNISHINGS & DECOR CATALOG



Dress up your space.
With Shepard, You Can.

TABLES

The product photos shown are representative of the products. Actual products and colors may vary from the images shown. Not every item or every color will be available on every event.

UNSKIRTED



Display Table
#50040
4' x 24" x 30"
Unskirted



Display Table
#50041
4' x 24" x 42"
Unskirted



Display Table
#50044
6' x 24" x 30"
Unskirted



Display Table
#50045
6' x 24" x 42"
Unskirted



Display Table
#50048
8' x 24" x 30"
Unskirted



Display Table
#50049
8' x 24" x 42"
Unskirted

SKIRTED

6' and 8' Long Tables are Skirted on 3 Sides. For Skirting on 4 Sides, please order 4th Side Skirt.



Display Table
#50042
4' x 24" x 30"
Skirted



Display Table
#50043
4' x 24" x 42"
Skirted



Display Table
#50046
6' x 24" x 30"
Skirted



Display Table
#50047
6' x 24" x 42"
Skirted



Display Table
#50050
8' x 24" x 30"
Skirted



Display Table
#50051
8' x 24" x 42"
Skirted

PEDESTAL & SIDE



30" Natural Pedestal Table
#50706
30" x 36"
Natural Feel Pedestal Table, Maple Top, Black Base



42" Natural Pedestal Table
#50707
42" x 36"
Natural Feel Pedestal Table, Maple Top, Black Base



30" Pedestal Table
#50032
30" x 36"
Pedestal Table, Grey Fleck Top, Chrome Base



42" Pedestal Table
#51089
42" x 36"
Round High Pedestal Table, Grey Fleck Top, Chrome Base



Round Side Table
#50030
18" x 24"



Square Side Table
#50031
18" x 18" x 24"

CHAIRS

The product photos shown are representative of the products. Actual products and colors may vary from the images shown. Not every item or every color will be available on every event.

STOOLS & CHAIRS WITH ARMS



Director's Stool
#51090
Black Fabric,
Maple Wood



Natural Feel Stool
#50705
Light Maple Back,
Black Fabric Seat



Padded Stool
#50024
Padded Stool with
Back, Grey Fabric



Director's Chair
#51086
Black Fabric,
Maple Wood



**Upholstered Arm
Chair**
#50021
Upholstered Arm Chair,
Grey Fabric

CHAIRS WITHOUT ARMS



Natural Feel Chair
#50704
Light Maple Back,
Black Fabric Seat



**Upholstered Side
Chair**
#50020
Upholstered Side Chair,
Grey Fabric

DISPLAYS

The product photos shown are representative of the products. Actual products and colors may vary from the images shown. Not every item or every color will be available on every event.

FOR HANGING



Bag Rack
#50175
9" x 12" x 71"
Adjustable Heights



Coat Rack
#50092
2" x 22" x 69"
Silver



Spiral Garment Rack
#50093
30" x 70"
Silver



2' x 8' Grid with Legs
#50236
2' x 8'
Chrome
Also Available Without
Legs (#50237)



3.5' x 8' Slatwall
#66147
3.5' x 8'
Grey



8' x 4' & 4' x 8' Peg Board
66148 (horz)
8' x 4'

#66149 (vert)
4' x 8'
White



6" Hooks for Peg Board
#50104
Silver



7-Ball Waterfall Grid Attachment
#50242
Silver
Also Available for Slat
Wall #50243

UPRIGHT, CROSSBARS & DRAPERY



8' High Upright with Base
#50088
Crossbar rented separately



6' - 10' Crossbar
#50349
1 3/4" D



7' - 12' Crossbar
#50348
1 3/4" D



3' High Drape
#50074



8' High Drape
#50073

SHELVING



4' x 12" Display Shelf
#50296
4' x 12"
White Shelf with Black
Bases



6' x 12" Display Shelf
#50297
6' x 12"
White Shelf with Black
Bases



Tensa Barrier Stanchion
#50427
Barrier with Black Belt
Barrier 13" x 41"
Black Belt 117"
Rented individually,
not a set

BARRIER

DISPLAYS & SHOWCASES

The product photos shown are representative of the products. Actual products and colors may vary from the images shown. Not every item or every color will be available on every event.

FOR SIGNS & LITERATURE



Horizontal Tackboard
#50060
4' x 8'
Black Legs, Grey Fabric



Vertical Tackboard
#50061
8' x 4'
Black Legs, Grey Fabric



Literature Rack
#50245
16" x 10" x 59"

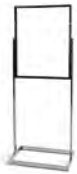

Chrome Sign Holder
#50095
Holds 22" x 28" Sign



Floor Easel
#50094
31" x 31" x 64"

OTHER



Wastebasket
#50091



Mini Refrigerator
#50098



Drawing Bowl
#50185



Sand Bag
#51087

SHOW CASES



4' Full View Showcase
#50067

6' Full View Showcase
#50068



4' Quarterview Showcase
#50069

6' Quarterview Showcase
#50070

FLOORING

The product photos shown are representative of the products. Actual products and colors may vary from the images shown. Not every item or every color will be available on every event.

EXPO - 13 OZ



Black

Tuxedo

Grey

Blue

Eclipse

Peacock

Red

Cayenne

Burgundy

PREMIUM - 28 OZ



Black

Deep Navy

Silver Cloud

Charcoal

Red

Beige

PLUSH - 50 OZ



Black

Dark Grey

Silver Dollar

Sand

White

Electric Blue

Navy

Crimson

VINYL - CUSTOM ORDER ONLY



Rosemary Stone

Snow

Maple

Silverwood

Walnut

Barnwood

SKIRT & DRAPE

The product photos shown are representative of the products. Actual products and colors may vary from the images shown. Not every item or every color will be available on every event.

SKIRT



Red

Burgundy

Gold

Green

Blue

Teal

White

Grey

Black

SKIRT - SPANDEX

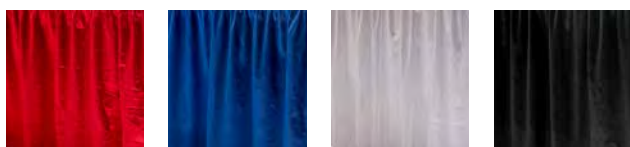

Red

Blue

White

Black

DRAPE



Red

Burgundy

Gold

Green

Blue

Teal

White

Grey

Black

STANDARD FURNISHINGS

NGAUS General Conference & Exhibition

I138120824

Huntington Place | Detroit, MI

August 24 - 26, 2024

ONLINE & DISCOUNT DEADLINE:* FRIDAY, AUGUST 2, 2024

* Order with complete Method of Payment must be received before Discount Deadline date to receive discounted pricing.

Tables

6' and 8' Skirted Tables have skirts on 3 sides, to have drape on all 4 sides you must order 4th side drape.

COLORS: Red (01), Green (02), White (03), Gold (04), Blue (05), Black (06), Burgundy (07), Grey (10), Teal (13) - **Spandex:** Red (01), White (03), Blue (05), Black (06)

CODE	ITEM	QTY	COLOR	ONLINE	DISCOUNT	REGULAR	TOTAL
50042	4' (l) x 24" (w) x 30" (h) Skirted Table			\$203.90	\$234.50	\$262.65	
50046	6' (l) x 24" (w) x 30" (h) Skirted Table			\$250.60	\$288.20	\$322.80	
50050	8' (l) x 24" (w) x 30" (h) Skirted Table			\$317.70	\$365.35	\$409.20	
50043	4' (l) x 24" (w) x 42" (h) Skirted Table			\$247.85	\$285.05	\$319.25	
50047	6' (l) x 24" (w) x 42" (h) Skirted Table			\$317.40	\$365.00	\$408.80	
50051	8' (l) x 24" (w) x 42" (h) Skirted Table			\$373.45	\$429.45	\$481.00	
50052	4th Side Skirt for 30" High Table			\$123.95	\$142.55	\$159.65	
50171	4th Side Skirt for 42" High Table			\$123.95	\$142.55	\$159.65	
50040	4' (l) x 24" (w) x 30" (h) UnSkirted Table		n/a	\$138.45	\$159.20	\$178.30	
50044	6' (l) x 24" (w) x 30" (h) UnSkirted Table		n/a	\$165.10	\$189.85	\$212.65	
50048	8' (l) x 24" (w) x 30" (h) UnSkirted Table		n/a	\$194.70	\$223.90	\$250.75	
50041	4' (l) x 24" (w) x 42" (h) UnSkirted Table		n/a	\$155.80	\$179.15	\$200.65	
50045	6' (l) 24" x (w) x 42" (h) UnSkirted Table		n/a	\$194.70	\$223.90	\$250.75	
50049	8' (l) x 24" (w) x 42" (h) UnSkirted Table		n/a	\$217.25	\$249.85	\$279.85	
51089	42" (h) Pedestal Table, 36" Diameter, Grey Fleck Top		n/a	\$312.00	\$358.80	\$401.85	
50032	30" (h) Pedestal Table, 36" Diameter, Grey Fleck Top		n/a	\$312.00	\$358.80	\$401.85	
50030	Round Side Table - 24" (w) x 18" (h)		n/a	\$164.15	\$188.75	\$211.40	
50031	Square Side Table - 24" (w) x 18" (h)		n/a	\$164.15	\$188.75	\$211.40	
50706	30" (h) Natural Pedestal Table, 36" Diameter, Maple Top		n/a	\$426.60	\$490.60	\$549.45	
50707	42" (h) Natural Pedestal Table, 36" Diameter, Maple Top		n/a	\$444.75	\$511.45	\$572.80	
50700	White Fabric Table Cover w/ 6'x30" Table		03	\$354.05	\$407.15	\$456.00	
50700	Red Fabric Table Cover w/ 6'x30" Table		01	\$354.05	\$407.15	\$456.00	
50700	Blue Fabric Table Cover w/ 6'x30" Table		05	\$354.05	\$407.15	\$456.00	
50700	Black Fabric Table Cover w/ 6'x30" Table		06	\$354.05	\$407.15	\$456.00	

Seating

CODE	ITEM	QTY	COLOR	ONLINE	DISCOUNT	REGULAR	TOTAL
50020	Side Chair Grey Fabric		n/a	\$126.15	\$145.05	\$162.45	
50021	Arm Chair Grey Fabric		n/a	\$172.10	\$197.90	\$221.65	
50024	Stool with Back Grey Fabric		n/a	\$209.65	\$241.10	\$270.05	
51086	Director's Chair Black Fabric		n/a	\$130.20	\$149.75	\$167.70	
51090	Director's Stool Black Fabric		n/a	\$233.05	\$268.00	\$300.15	
50705	Natural Feel Stool Maple Back, Black Fabric Seat		n/a	\$254.15	\$292.25	\$327.30	
50704	Natural Feel Chair, Maple Back, Black Fabric Seat		n/a	\$208.70	\$240.00	\$268.80	

Submission of this form indicates you read and accept the Payment Policy and Terms & Conditions. There are no exchanges or refunds once item has been delivered to your booth. Cancellations must be received in writing 14 days prior to first exhibitor move in day. Rental items found and in use in your booth are subject to "Regular" pricing.

TOTAL ESTIMATE \$ _____

TAX (All tax rates are subject to change) 6.00%

AMOUNT DUE \$ _____

COMPANY NAME: _____ BOOTH NUMBER: _____

CONTACT NAME: _____

EMAIL ADDRESS: _____



Email completed form to: orders@shepardes.com

SPECIALTY, DISPLAYS & DRAPERY

NGAUS General Conference & Exhibition

I138120824

Huntington Place | Detroit, MI

August 24 - 26, 2024

ONLINE & DISCOUNT DEADLINE:* FRIDAY, AUGUST 2, 2024

* Order with complete Method of Payment must be received before Discount Deadline date to receive discounted pricing.

CODE	ITEM	QTY	COLOR	ONLINE	DISCOUNT	REGULAR	TOTAL
50091	Wastebasket		n/a	\$19.00	\$19.00	\$19.00	
50094	Floor Easel, Chrome		n/a	\$69.90	\$80.40	\$90.05	
50245	Literature Rack Silver, Glass		n/a	\$257.80	\$296.45	\$332.00	
50175	Bag Rack, Chrome		n/a	\$341.40	\$392.60	\$439.70	
50092	Coat Rack, Chrome		n/a	\$121.25	\$139.45	\$156.20	
50093	Garment Rack, Chrome		n/a	\$341.40	\$392.60	\$439.70	
50427	Tensabarrier, Per Stem, Black		n/a	\$143.95	\$165.55	\$185.40	
51087	Sand Bag		n/a	\$32.50	\$32.50	\$32.50	
50095	Sign Holder, 22" x 28" Chrome		n/a	\$159.00	\$182.85	\$204.80	
50185	Drawing Bowl, Clear		n/a	\$64.10	\$73.70	\$82.55	
50296	4' x 12" Display Riser White and Black		n/a	\$144.15	\$165.75	\$185.65	
50297	6' x 12" Display Riser White and Black		n/a	\$179.40	\$206.30	\$231.05	
50098	Mini Refrigerator, Approx. 3 cubic feet		n/a	\$544.45	\$626.10	\$701.25	
50067	4' Full View Showcase, White		n/a	\$1,286.40	\$1,479.35	\$1,656.85	
50068	6' Full View Showcase, White		n/a	\$1,418.75	\$1,631.55	\$1,827.35	
50069	4' Quarter View Showcase, White		n/a	\$1,286.40	\$1,479.35	\$1,656.85	
50070	6' Quarter View Showcase, White		n/a	\$1,418.75	\$1,631.55	\$1,827.35	
50060	4' x 8' Horizontal Posterboard Grey Fabric		n/a	\$416.60	\$479.10	\$536.60	
50061	4' x 8' Vertical Posterboard Grey Fabric		n/a	\$416.60	\$479.10	\$536.60	
50236	Grids 2' x 8' with Legs, Each		n/a	\$307.70	\$353.85	\$396.30	
50237	Grid 2' x 8' without Legs, Each		n/a	\$230.45	\$265.00	\$296.80	
50242	7-Ball Waterfall for Grids		n/a	\$21.20	\$24.40	\$27.35	
50104	6" Hooks (12) for Peg Boards		n/a	\$67.80	\$77.95	\$87.30	

50073	8' High Drape on a Cross Bar, per linear foot (minimum 5' linear feet rental)			\$32.70	\$37.60	\$42.10	
50074	3' High Drape on a Cross Bar, per linear foot (minimum 5' linear feet rental)			\$24.25	\$27.90	\$31.25	
50088	8' Upright with Base		n/a	\$45.10	\$51.85	\$58.05	
52065	3' Upright with Base		n/a	\$45.10	\$51.85	\$58.05	
50349	6-10' Crossbar		n/a	\$29.95	\$34.45	\$38.60	
50348	7-12' Crossbar		n/a	\$29.95	\$34.45	\$38.60	
50058	Sateen, per linear foot (minimum 5' linear feet rental)			\$27.95	\$32.15	\$36.00	

DRAPERY COLORS: Red (01), White (03), Gold (04), Blue (05), Black (06), Burgundy (07), Grey (10)

TOTAL ESTIMATE	\$ _____
TAX (All tax rates are subject to change)	6.00%
AMOUNT DUE	\$ _____

Submission of this form indicates you read and accept the Payment Policy and Terms & Conditions. There are no exchanges or refunds once item has been delivered to your booth. Cancellations must be received in writing 14 days prior to first exhibitor move in day. Rental items found and in use in your booth are subject to "Regular" pricing.

COMPANY NAME: _____ BOOTH NUMBER: _____

CONTACT NAME: _____

EMAIL ADDRESS: _____



Email completed form to: orders@shepardes.com

NGAUS General Conference & Exhibition
 Huntington Place | Detroit, MI
 August 24 - 26, 2024

I138120824

ONLINE & DISCOUNT DEADLINE:* FRIDAY, AUGUST 2, 2024
PREMIUM PLUSH & PREMIUM VINYL DEADLINE: THURSDAY, JULY 25, 2024**

* Order with complete Method of Payment must be received before Discount Deadline date to receive discounted pricing.

CODE	ITEM	SQ. FT.	COLOR	ONLINE	DISCOUNT	REGULAR	TOTAL
46004	Premium Plush Carpet** - 50 oz. (per sq. ft.)*** Rental includes installation and removal of carpet and visqueen.			\$13.80	\$15.85	\$17.75	

AVAILABLE COLORS: Black (06), Dark Grey (35), Silver Dollar (34), Sand (33), White (03), Electric Blue (91), Navy (22), Crimson (74) *** Minimum 100 sq. ft. order required.

CODE	ITEM	SQ. FT.	COLOR	ONLINE	DISCOUNT	REGULAR	TOTAL
46005	Premium Vinyl** (per sq. ft.)*** Rental includes installation and removal of carpet and visqueen.			\$17.80	\$20.45	\$22.90	
46007	1/2" Padding for Vinyl (per sq. ft.)***		n/a	\$6.50	\$7.45	\$8.35	

AVAILABLE COLORS: Rosemary Stone (64), Snow (89), Maple (66), Silverwood (25), Walnut (39), Barnwood (85) *** Minimum 100 sq. ft. order required.

CODE	ITEM	SQ. FT.	COLOR	ONLINE	DISCOUNT	REGULAR	TOTAL
46001	Premium Carpet - 28 oz. Rental/Sq. Ft.*** Rental includes installation and removal of carpet and visqueen.			\$9.90	\$11.40	\$12.75	
46003	Premium Carpet - 28 oz. Rental 1000+ Sq. Ft.*** Rental includes installation and removal of carpet and visqueen.			\$8.65	\$9.95	\$11.15	
46002	Premium Carpet - 28 oz. Purchase Sq. Ft.*** Rental includes installation and removal of carpet and visqueen.			\$24.45	\$28.10	\$31.45	

100% ULTRA CUT PILE WITH ACTION BACK OR JUTE BACKING AVAILABLE COLORS: Black (06), Deep Navy (22), Silver Cloud (18), Charcoal (17), Red (01), Beige (14) *** Minimum 100 sq. ft. order required.

CODE	ITEM	SQ. FT.	COLOR	ONLINE	DISCOUNT	REGULAR	TOTAL
50255	Expo Carpet - 13 oz. (Regular & Special Cut) 10' x 10'			\$348.35	\$400.60	\$448.65	
50256	Expo Carpet - 13 oz. (Regular & Special Cut) 10' x 20'			\$627.00	\$721.05	\$807.60	
50257	Expo Carpet - 13 oz. (Regular & Special Cut) 10' x 30'			\$940.50	\$1,081.55	\$1,211.35	
50258	Expo Carpet - 13 oz. (Regular & Special Cut) 10' x 40'			\$1,254.00	\$1,442.10	\$1,615.15	

RECOMMENDED FOR: Standard Size and Inline Booths AVAILABLE COLORS: Black (06), Tuxedo (50), Grey (10), Blue (05), Eclipse (43), Peacock (13), Red (01), Cayenne (92) Burgundy (07) - Variation in dye lot may occur when ordering more than one cut of carpet unless ordered as Special Cut.

CODE	ITEM	SQ. FT.	COLOR	ONLINE	DISCOUNT	REGULAR	TOTAL
50580	Special Cut 0-399 Sq. Ft. Rental includes installation and removal of carpet and visqueen.			\$6.70	\$7.70	\$8.60	
50581	Special Cut 400-900 Sq. Ft. Rental includes installation and removal of carpet and visqueen.			\$6.15	\$7.05	\$7.90	
50582	Special Cut 900+ Sq. Ft. Rental includes installation and removal of carpet and visqueen.			\$5.60	\$6.45	\$7.20	

RECOMMENDED FOR: Island and Large Area Exhibits AVAILABLE COLORS: Black (06), Tuxedo (50), Grey (10), Blue (05), Eclipse (43), Peacock (13), Red (01), Cayenne (92) Burgundy (07) - Order Special Cut when it is important that dye lots match.

CODE	ITEM	SQ. FT.	COLOR	ONLINE	DISCOUNT	REGULAR	TOTAL
50009	1/2" Padding		n/a	\$1.80	\$2.05	\$2.30	
50008	1" Padding		n/a	\$3.45	\$3.95	\$4.40	
50010	Visqueen		n/a	\$0.45	\$0.50	\$0.55	

ENTICE ATTENDEES TO LINGER IN YOUR SPACE WITH SOFT, COMFORTABLE PADDING.

TOTAL ESTIMATE	\$ _____
TAX (All tax rates are subject to change)	6.00%
AMOUNT DUE	\$ _____

Interested in Elevated Hardwood? Contact us for a quote at: exhibits@shepardes.com.

Submission of this form indicates you read and accept the Payment Policy and Terms & Conditions. There are no exchanges or refunds once item has been delivered to your booth. Cancellations must be received in writing 14 days prior to first exhibitor move in day. Rental items found and in use in your booth are subject to "Regular" pricing.

COMPANY NAME: _____ BOOTH NUMBER: _____

CONTACT NAME: _____

EMAIL ADDRESS: _____



Email completed form to: orders@shepardes.com



CORT®

EVENTS

2023

TRADESHOW CATALOG

EXCITING NEW PRODUCTS AND TIPS TO HELP PLAN YOUR NEXT TRADESHOW EXHIBIT

FURNITURE



FLEXIBILITY

When you partner with CORT, you always get a tradeshow experience that goes beyond expectation. More responsiveness. More flexibility. More expertise. More of what exhibitors and show management need to set their company up for success. At the end of the day, we don't just rent furniture to fill an expo space, we deliver standout service that endures long after the booths are loaded into the truck. That's the power of more.

CORT Events. Experiences and beyond.

Table of Contents

- 2 Introduction
- 3 Table of Contents
- 4 Top Design Tips**
- 6 Soft Seating**
- 7 Club Chairs
- 12 Powered Seating
- 13 Accent Chairs
- 17 Group Seating**
- 22 Ottomans
- 25 Bars
- 26 Bar Seating**
- 30 Bar & Café Tables**
- 34 Communal Tables
- 35 Powered Product**
- 37 Accent Tables**
- 41 Side Tables**
- 42 Office & Storage Essentials
- 43 Executive Conference Tables
- 46 Executive Seating
- 48 Counters and Pedestals
- 49 Essential Accessories, Lighting and Greenery**



TOP DESIGN TIPS

for
Tradeshow
Exhibits

Use these tips to bring your space to life and empower clients to make it their own.

1 Work Together

Enjoy communal tables that make it easy to network and build connections.



2 Sit Back & Relax

Let clients relax in comfortable "living room" spaces that encourage real conversations.



3 Take It for a Spin

Great for smaller spaces, swivel chairs increase functionality so you can engage and interact.



4 One With Nature

Bring nature indoors with life like greenery that warms up booths and other environments.



5 Small, but Mighty

Got small spaces? Use ottomans in small theaters for quick demonstrations.



TOP DESIGN TIPS for Tradeshow Exhibits

Use these tips to bring your space to life and empower clients to make it their own.

6 Highs from Lows

Use low and casual seating to create a comfortable learning environment that makes clients feel at ease.



7 Power up!

Include powered products throughout your space that empower clients to recharge, relax, and relate with others.



8 In the Loop

Create an informal, inclusive setting for small group discussions with ottomans styled around an accent table.



9 Make it Pop!

Add flashes of color throughout your furnishings to attract more attention while reinforcing brand themes.

10 Create space

Sometimes, clients need privacy. Use clear dividers between sofas or conference tables to give clients space for personal meetings.



11 Share the look.

Increase your brand exposure by sharing eye-catching spaces on your social networks.



SOFT SEATING



Allegro Sofa



Baja Sofa & Loveseat



Cordoba Loveseat



Fairfax Sofa



Key Largo Sofa & Loveseat



Montreal Loveseat



Naples Sofa & Loveseat



Naples Sofa & Loveseat - Powered



Palm Beach Sofa



Sterling Sofa



Valencia Sofa

CLUB CHAIRS



Allegro Chair



Baja Chair



Cordoba Chair



Fairfax Chair



Key Largo Chair



Montreal Chair



Naples Chair



Naples Chair - Powered



Sterling Chair







Valencia Chair





Product Image	Product Name	Product Code	Color/Materials	Dimensions
	Allegro Chair	CHR002	Blue Fabric	Length: 36" Depth: 34.5" Height: 30" Seat Length: 23" Seat Depth: 23" Seat Height: 17"
	Allegro Sofa	SFA002	Blue Fabric	Length: 73" Depth: 34.5" Height: 30" Seat Length: 61" Seat Depth: 23" Seat Height: 17"
	Baja Chair	BCHWHT	White Vinyl	Length: 36" Depth: 30.5" Height: 28" Seat Length: 25.75" Seat Depth: 22" Seat Height: 16"
	Baja Loveseat	BLVWHT	White Vinyl	Length: 61" Depth: 30.5" Height: 28" Seat Length: 51" Seat Depth: 23" Seat Height: 16"
	Baja Sofa	BSFWHT	White Vinyl	Length: 86" Depth: 30" Height: 28" Seat Length: 77" Seat Depth: 23" Seat Height: 16"
	Cordoba Chair	COCHTP	Taupe Fabric, Black	Length: 37" Depth: 32" Height: 33" Seat Length: 22.5" Seat Depth: 21" Seat Height: 18"

Product Image	Product Name	Product Code	Color/Materials	Dimensions
	Cordoba Loveseat	COLVTP	Taupe Fabric, Black	Length: 60.5" Depth: 32" Height: 33" Seat Length: 46" Seat Depth: 21" Seat Height: 18"
	Fairfax Chair	FAIRCW	White Vinyl, Brushed Metal	Length: 27" Depth: 26" Height: 30" Seat Length: 24" Seat Depth: 20.5" Seat Height: 17"
	Fairfax Sofa	FAIRSW	White Vinyl, Brushed Metal	Length: 62" Depth: 26" Height: 30" Seat Length: 62" Seat Depth: 20.5" Seat Height: 17"
	Key Largo Chair	KEYCHR	Black Fabric, Wood	Length: 35" Depth: 35" Height: 34" Seat Length: 22" Seat Depth: 22" Seat Height: 19"
	Key Largo Loveseat	KEYLOV	Black Fabric, Wood	Length: 57" Depth: 35" Height: 34" Seat Length: 44" Seat Depth: 22" Seat Height: 19"
	Key Largo Sofa	KEYSOF	Black Fabric, Wood	Length: 79" Depth: 35" Height: 34" Seat Length: 66" Seat Depth: 22" Seat Height: 19"

Product Image	Product Name	Product Code	Color/Materials	Dimensions
	Montreal Chair	MONCHA	Blue, Black Metal	Length: 30" Depth: 23.25" Height: 30" Seat Length: 22.5" Seat Depth: 18.5" Seat Height: 16"
	Montreal Loveseat	MONLOV	Blue, Black Metal	Length: 62" Depth: 27.25" Height: 29.5" Seat Length: 57" Seat Depth: 18.5" Seat Height: 16"
	Naples Chair	Powered: NPLCHP Non-Powered: NPLCHR	Black Vinyl	Length: 36" Depth: 30" Height: 33.25" Seat Length: 25" Seat Depth: 20.5" Seat Height: 18"
	Naples Loveseat	Powered: NPLLOP Non-Powered: NPLLOV	Black Vinyl	Length: 62" Depth: 30" Height: 33.25" Seat Length: 52.5" Seat Depth: 20.5" Seat Height: 18"
	Naples Sofa	Powered: NPLSOP Non-Powered: NPLSOF	Black Vinyl	Length: 87" Depth: 30" Height: 33.25" Seat Length: 77.5" Seat Depth: 20.5" Seat Height: 18"
	Palm Beach Sofa	PALSOF	White Vinyl	Length: 69" Depth: 29" Height: 33" Seat Length: 48-62" Seat Depth: 19" Seat Height: 18"

Product Image	Product Name	Product Code	Color/Materials	Dimensions
	Sterling Chair	STECHA	Gray Fabric	Length: 33" Depth: 33.5" Height: 32" Seat Length: 25.75" Seat Depth: 21" Seat Height: 17"
	Sterling Sofa	STESOF	Gray Fabric	Length: 82" Depth: 33.5" Height: 32" Seat Length: 72.5" Seat Depth: 21" Seat Height: 17"
	Valencia Chair	VALCHA	Spice Orange Velvet	Length: 28" Depth: 30.5" Height: 31" Seat Length: 17.5" Seat Depth: 21" Seat Height: 17.5"
	Valencia Sofa	VALSOF	Coffee Brown Velvet	Length: 63" Depth: 30.5" Height: 31" Seat Length: 53" Seat Depth: 20.5" Seat Height: 17.5"



Product Image	Product Name	Product Code	Color/Materials	Dimensions
	Naples Chair	Powered: NPLCHP Non-Powered: NPLCHR	Black Vinyl	Length: 36" Depth: 30" Height: 33.25" Seat Length: 25" Seat Depth: 20.5" Seat Height: 18"
	Naples Loveseat	Powered: NPLLOP Non-Powered: NPLLOV	Black Vinyl	Length: 62" Depth: 30" Height: 33.25" Seat Length: 52.5" Seat Depth: 20.5" Seat Height: 18"
	Naples Sofa	Powered: NPLSOP Non-Powered: NPLSOF	Black Vinyl	Length: 87" Depth: 30" Height: 33.25" Seat Length: 77.5" Seat Depth: 20.5" Seat Height: 18"
	Tech Tablet Chair	TCHGRY	Gray Vinyl, White Metal Tablet, Chrome Base	Length: 30.5" Depth: 29" Height: 33.5" Seat Length: 22.5" Seat Depth: 19.5" Seat Height: 19"
	Tech Chair, No Tablet	TCHP	Gray Vinyl, Chrome Base	Length: 30.5" Depth: 29" Height: 33.5" Seat Length: 22.5" Seat Depth: 19.5" Seat Height: 19"



ACCENT CHAIRS



Atherton Chair



Bowery Chair



Century Chair



La Brea Swivel Chair



Brooklyn Meeting Chair Collection



Lena Chair



Madrid Chair



Munich Armless Chair



Pasadena Chair









Pro Executive Guest Chair













Swanson Swivel Chair



Wentworth Swivel Chair

Product Image	Product Name	Product Code	Color/Materials	Dimensions
	Atherton Chair	ATHCHA	Brown Leather, Black Metal	Length: 27" Depth: 31" Height: 30" Seat Length: 21.5" Seat Depth: 24" Seat Height: 17"
	Bowery Chair	BOWCHA	Ochre Fabric	Length: 29.75" Depth: 31" Height: 27.25" Seat Length: 30" Seat Depth: 21" Seat Height: 17"
	Brooklyn Meeting Chair	BNMCSW	White Vinyl, Black Swivel Base	Length: 24.5" Depth: 25.5" Height: 31.75" Seat Length: 18" Seat Depth: 17" Seat Height: 18"
	Brooklyn Meeting Chair	BNMCSB	Black Vinyl, Black Swivel Base	Length: 24.5" Depth: 25.5" Height: 31.75" Seat Length: 18" Seat Depth: 17" Seat Height: 18"
	Brooklyn Meeting Chair	BNMCOW	White Vinyl, Oak-Look Base	Length: 24.5" Depth: 25.5" Height: 31.75" Seat Length: 18" Seat Depth: 17" Seat Height: 18"
	Brooklyn Meeting Chair	BNMCOB	Black Vinyl, Oak-Look Base	Length: 24.5" Depth: 25.5" Height: 31.75" Seat Length: 18" Seat Depth: 17" Seat Height: 18"

Product Image	Product Name	Product Code	Color/Materials	Dimensions
	Century Chair	CNTCHR	Gray Velvet	Length: 30" Depth: 30" Height: 31" Seat Length: 21.5" Seat Depth: 23" Seat Height: 17"
	La Brea Swivel Chair	LABREA	Charcoal Gray Fabric, Chrome	Length: 35" Depth: 27" Height: 40" Seat Length: 17" Seat Depth: 16" Seat Height: 20"
	Lena Chair	LENCHA	Moss Green Leather, Bronze	Length: 27" Depth: 25" Height: 31" Seat Length: 18.5" Seat Depth: 21" Seat Height: 19"
	Madrid Chair	BCW	White Vinyl, Chrome	Length: 30" Depth: 30" Height: 31" Seat Length: 30.5" Seat Depth: 20.5" Seat Height: 18"
	Munich Armless Chair	MNCHCH	Gray Fabric, Black	Length: 22.5" Depth: 27" Height: 28.5" Seat Length: 22" Seat Depth: 21" Seat Height: 17"
	Pasadena Chair	PASCHR	White Molded Plastic, Chrome Tower Base	Length: 27" Depth: 25" Height: 26" Seat Length: 17" Seat Depth: 17" Seat Height: 17"

Product Image	Product Name	Product Code	Color/Materials	Dimensions
	<p>Pro Executive Guest Chair</p>	<p>PROGB</p>	<p>Black Vinyl, Chrome</p>	<p>Length: 24" Depth: 26" Height: 36" Seat Length: 19.5" Seat Depth: 19" Seat Height: 18"</p>
	<p>Swanson Swivel Chair</p>	<p>SWAN</p>	<p>Black Vinyl</p>	<p>Length: 28" Depth: 25" Height: 30" Seat Length: 22" Seat Depth: 17.5" Seat Height: 17"</p>
	<p>Tech Tablet Chair</p>	<p>TCHGRY</p>	<p>Gray Vinyl, White Metal Tablet, Chrome Base</p>	<p>Length: 30.5" Depth: 29" Height: 33.5" Seat Length: 22.5" Seat Depth: 19.5" Seat Height: 19"</p>
	<p>Tech Chair, No Tablet</p>	<p>TCHP</p>	<p>Gray Vinyl, Chrome Base</p>	<p>Length: 30.5" Depth: 29" Height: 33.5" Seat Length: 22.5" Seat Depth: 19.5" Seat Height: 19"</p>
	<p>Wentworth Swivel Chair</p>	<p>WENCHA</p>	<p>Brown Vinyl</p>	<p>Length: 31" Depth: 24" Height: 31.5" Seat Length: 21.5" Seat Depth: 19" Seat Height: 18"</p>

GROUP SEATING



Blade Chair Collection

Brewer Chair



Chelsea Chair Collection



Christopher Chair



Duet Stack Chair



Laguna Chair



Lucent Chair



Malba Chair Collection



Marina Chair Collection



Razor Chair







Rustique Chair









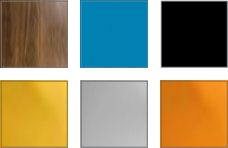

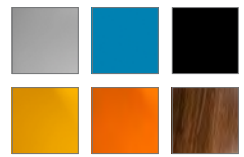

Syntax Chair







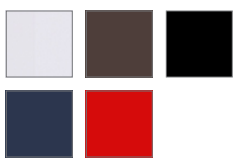



Zenith Chair





Product Image	Product Name	Product Code	Color/Materials	Dimensions
 	<p>Blade Chair</p>	<p>BLDCBK BLDCRD BLDCSB</p>	<p>Black Red Sky Blue</p>	<p>Length: 20.5" Depth: 19" Height: 30.5" Seat Length: 15" Seat Depth: 16.75" Seat Height: 17.75"</p>
	<p>Brewer Chair</p>	<p>SC3</p>	<p>Onyx, Chrome</p>	<p>Length: 20" Depth: 20" Height: 32" Seat Length: 19.5" Seat Depth: 16.5"</p>
 	<p>Chelsea Chair</p>	<p>CCBTWL CCBTAZ CCBTBK CCBTYL CCBTGY CCBTOR</p>	<p>Walnut-Look, Black Tower Base Azure Blue, Black Tower Base Black, Black Tower Base Goldenrod Yellow, Black Tower Base Gray, Black Tower Base Orange, Black Tower Base</p>	<p>Length: 18.5" Depth: 22" Height: 34" Seat Length: 18" Seat Depth: 16" Seat Height: 18.5"</p>



Product Image	Product Name	Product Code	Color/Materials	Dimensions
 	Chelsea Chair	CCSCGY CCSCAZ CCSCBK CCSCYL CCSCOR CCSCWL	Gray, Black Swivel Base w/ Casters Azure Blue, Black Swivel Base w/ Casters Black, Black Swivel Base w/ Casters Goldenrod Yellow, Black Swivel Base w/ Casters Orange, Black Swivel Base w/ Casters Walnut-Look, Black Swivel Base w/ Casters	Length: 18.5" Depth: 22" Height: 34" Seat Length: 18" Seat Depth: 16" Seat Height: 18.5"
	Christopher Chair	XCHR	White Vinyl, Chrome	Length: 17" Depth: 19" Height: 35" Seat Length: 16.75" Seat Depth: 14.75" Seat Height: 18"
	Duet Stack Chair	DUET	Black, Chrome	Length: 21" Depth: 23" Height: 33" Seat Length: 18" Seat Depth: 18" Seat Height: 18"
	Laguna Chair	LMCHR	Maple, Chrome	Length: 18" Depth: 19" Height: 34" Seat Length: 17" Seat Depth: 16" Seat Height: 18"
	Lucent Chair	LUCHCL	Frosted Acrylic, Chrome	Length: 19.5" Depth: 19.75" Height: 32.5" Seat Length: 16.25" Seat Depth: 15.5" Seat Height: 18.75"

Product Image	Product Name	Product Code	Color/Materials	Dimensions
	Malba Chair	MALGRY	Gray, Chrome	Length: 20" Depth: 20" Height: 32" Seat Length: 17" Seat Depth: 14" Seat Height: 19"
	Malba Chair	MALGRN	Green, Chrome	Length: 20" Depth: 20" Height: 32" Seat Length: 17" Seat Depth: 14" Seat Height: 19"
 	Marina Chair	MARCWH MARCBR MARCBK MARCBE MARCRD	White Vinyl, Brushed Metal Brown Fabric, Brushed Metal Black Vinyl, Brushed Metal Ocean Blue Fabric, Brushed Metal Red Fabric, Brushed Metal	Length: 17.5" Depth: 19.5" Height: 35" Seat Length: 15" Seat Depth: 13" Seat Height: 19"
	Razor Armless Chair	SC10	White	Length: 19" Depth: 23.5" Height: 31.75" Seat Length: 16" Seat Depth: 17.25" Seat Height: 17.75"
	Rustique Chair w/ Arms	RSTDIN	Gunmetal	Length: 20" Depth: 18" Height: 31" Seat Length: 15" Seat Depth: 15" Seat Height: 18"





Product Image	Product Name	Product Code	Color/Materials	Dimensions
	<p>Syntax Chair</p>	<p>CS4</p>	<p>Black, Chrome</p>	<p>Length: 23" Depth: 19" Height: 32.25" Seat Length: 18" Seat Depth: 17" Seat Height: 18.5"</p>
	<p>Zenith Chair</p>	<p>ZENCHR</p>	<p>White, Chrome</p>	<p>Length: 18.25" Depth: 22" Height: 32" Seat Length: 18.25" Seat Depth: 16" Seat Height: 19"</p>

Product Image	Product Name	Product Code	Color/Materials	Dimensions
 	<p>Beverly Bench Ottoman</p>	<p>BVLYBK BVLYBN BVLYGR BVLYLN BVLYOB BVLYRD BVLYWH</p>	<p>Black Vinyl Brown Fabric Gray Fabric Linen Fabric Ocean Blue Fabric Red Fabric White Vinyl</p>	<p>Length: 60" Depth: 20" Height: 18" Seat Length: 60" Seat Depth: 20" Seat Height: 18"</p>
 	<p>Beverly Small Bench Ottoman</p>	<p>BVSMBK BVSMBN BVSMGY BVSMMLV BVSMMLN BVSMBL BVSMGN BVSMOR BVSMRD BVSMWH BVSMYL</p>	<p>Black Vinyl Brown Fabric Gray Fabric Lavender Fabric Linen Fabric Ocean Blue Fabric Olive Green Fabric Orange Fabric Red Fabric White Vinyl Yellow Fabric</p>	<p>Length: 60" Depth: 20" Height: 18" Seat Length: 60" Seat Depth: 20" Seat Height: 18"</p>
	<p>Endless Curved Ottoman</p>	<p>END01B</p>	<p>Black Vinyl, Chrome</p>	<p>Length: 60.5" Depth: 37.5" Height: 15" Seat Length: 60.5" Seat Depth: 34"</p>
	<p>Endless Curved Ottoman</p>	<p>END01W</p>	<p>White Vinyl, Chrome</p>	<p>Length: 60.5" Depth: 37.5" Height: 15" Seat Length: 60.5" Seat Depth: 34"</p>

Product Image	Product Name	Product Code	Color/Materials	Dimensions
	<p>Endless Square Ottoman</p>	<p>END02B</p>	<p>Black Vinyl, Chrome</p>	<p>Length: 34" Depth: 34" Height: 15" Seat Length: 34" Seat Depth: 34"</p>
	<p>Endless Square Ottoman</p>	<p>END02W</p>	<p>White Vinyl, Chrome</p>	<p>Length: 34" Depth: 34" Height: 15" Seat Length: 34" Seat Depth: 34"</p>
 	<p>Marche Swivel Ottoman</p>	<p>MAR001 MAR015 MAR010 MAR014 MAR012 MAR002 MAR016 MAR003 MAR008 MAR011 MAR009 MAR007 MAR004 MAR005 MAR006 MAR013</p>	<p>White Vinyl Black Vinyl Blue Fabric Distressed Brown Vinyl Forest Green Vinyl Gray Fabric Ivory Faux Sheep Fur Linen Fabric Meadow Green Orange Velvet Pear Yellow Fabric Plum Fabric Raspberry Fabric Red Fabric Rose Quartz Fabric Teal Velvet</p>	<p>Round: 17" Height: 18" Seat Round: 17" Seat Height: 18"</p>
	<p>Regis Bench</p>	<p>REGBEN</p>	<p>Brushed Metal</p>	<p>Length: 47" Depth: 15.5" Height: 16"</p>

Product Image	Product Name	Product Code	Color/Materials	Dimensions
 	<p>Vibe Cube Ottoman</p>	<p>VIB10 VIB02 VIB05 VIB14 VIB17 VIB01 VIB08 VIB13 VIB04 VIB12 VIB16 VIB11 VIB15 VIB09</p>	<p>Black Vinyl Blue Vinyl Bright Yellow Vinyl Citrus Green Vinyl Desert Rose Vinyl Green Vinyl Orange Vinyl Purple Vinyl Red Vinyl Silver Vinyl Spice Orange Vinyl Steel Blue Vinyl Taupe Vinyl White Vinyl</p>	<p>Length: 18" Depth: 18" Height: 18" Seat Length: 18" Seat Depth: 18" Seat Height: 18"</p>



Product Image	Product Name	Product Code	Color/Materials	Dimensions
	<p>Midtown Bar, Lighted w/ Plug In</p>  	<p>MTBLPI</p>	<p>Taupe Glass Top, Pewter</p>	<p>Length: 60" Depth: 18" Height: 42"</p>
	<p>Midtown Bar, Unlighted</p> 	<p>MTBUUL</p>	<p>Taupe Glass Top, Pewter</p>	<p>Length: 60" Depth: 18" Height: 42"</p>

BAR SEATING



Banana Barstool Collection



Blade Barstool Collection



Chelsea Barstool Collection



Christopher Barstool



Laguna Barstool



Lift Barstool Collection



Lucent Barstool



Marina Barstool Collection



Rustique Barstool



Shark Barstool













Syntax Barstool







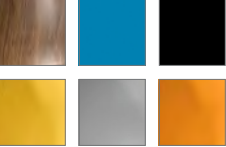



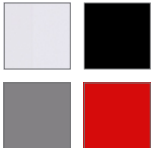

Zenith Barstool

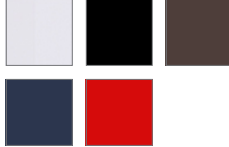









Zoey Barstool

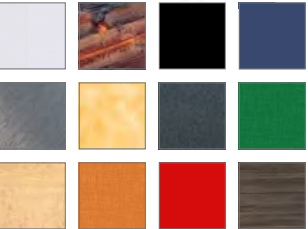



Product Image	Product Name	Product Code	Color/Materials	Dimensions
	<p>Banana Barstool</p> 	<p>BSS</p>	<p>Black, Chrome</p>	<p>Length: 21" Depth: 22" Height: 41" Seat Length: 18" Seat Depth: 18" Seat Height: 30.25"</p>
	<p>Banana Barstool</p> 	<p>BST</p>	<p>White, Chrome</p>	<p>Length: 21" Depth: 22" Height: 41" Seat Length: 18" Seat Depth: 18" Seat Height: 30.25"</p>
 	<p>Blade Barstool</p>  	<p>BLDBBK BLDBRD BLDBSB</p>	<p>Black Red Sky Blue</p>	<p>Length: 20.5" Depth: 20" Height: 40.5" Seat Length: 14" Seat Depth: 15.75" Seat Height: 30.25"</p>
 	<p>Chelsea Barstool</p> 	<p>CBSBWL CBSBAZ CBSBBK CBSBYL CBSBGY CBSBOR</p>	<p>Walnut-Look, Black Tower Base Azure Blue, Black Tower Base Black, Black Tower Base Goldenrod Yellow, Black Tower Base Gray, Black Tower Base Orange, Black Tower Base</p>	<p>Length: 20.5" Depth: 20" Height: 40.5" Seat Length: 14" Seat Depth: 15.75" Seat Height: 30.25"</p>

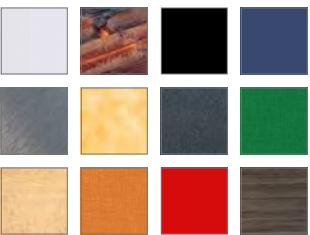

Product Image	Product Name	Product Code	Color/Materials	Dimensions
	<p>Christopher Barstool</p>	<p>XBAR</p>	<p>White Vinyl, Chrome</p>	<p>Length: 19" Depth: 19" Height: 41" Seat Length: 14.5" Seat Depth: 15" Seat Height: 29"</p>
	<p>Laguna Barstool</p>	<p>LMBAR</p>	<p>Maple, Chrome</p>	<p>Length: 18" Depth: 20" Height: 47" Seat Length: 17" Seat Depth: 16" Seat Height: 31"</p>
 	<p>Lift Barstool</p>	<p>ROLLWH ROLLBL ROLLGY ROLLRD</p>	<p>White Vinyl, Chrome Black Vinyl, Chrome Gray Vinyl, Chrome Red Vinyl, Chrome</p>	<p>Round: 18" Height: 23-33.5" Seat Round: 15" Seat Height: 22.25-31.5"</p>
 	<p>Marina Barstool</p>	<p>MARBWH MARBBK MARBBR MARBBE MARBRD</p>	<p>White Vinyl, Brushed Metal Black Vinyl, Brushed Metal Brown Fabric, Brushed Metal Ocean Blue Fabric, Brushed Metal Red Fabric, Brushed Metal</p>	<p>Length: 21" Depth: 17.5" Height: 41.5" Seat Length: 17" Seat Depth: 16" Seat Height: 30.5"</p>







Product Image	Product Name	Product Code	Color/Materials	Dimensions
	Lucent Barstool	LUBSCL	Frosted Acrylic, Chrome	Length: 22" Depth: 22.5" Height: 45.5" Seat Length: 16.25" Seat Depth: 15.5" Seat Height: 31"
	Rustique Barstool	RSTSTL	Gunmetal	Length: 13" Depth: 13" Height: 30" Seat Length: 12" Seat Depth: 12" Seat Height: 30"
	Shark Barstool	BS001	White, Chrome	Length: 22" Depth: 19" Height: 34-44" Seat Length: 17.5" Seat Depth: 14.5" Seat Height: 21.5-32"
	Syntax Barstool	BSR	Black, Chrome	Length: 23" Depth: 19" Height: 43.25" Seat Length: 18" Seat Depth: 17" Seat Height: 28.5"
	Zenith Barstool	ZENBAR	White, Chrome	Length: 19" Depth: 20" Height: 44" Seat Length: 18" Seat Depth: 16" Seat Height: 29"
	Zoey Barstool	BS002	White, Chrome	Length: 15" Depth: 16" Height: 30-34.75" Seat Length: 14" Seat Depth: 13" Seat Height: 26-30.5"

Product Image	Product Name	Product Code	Color/Materials	Dimensions
 	<p>30" Round Bar Table w/ Hydraulic Base</p>	<p>30WHHB 30WDHB 30BKHB 30BEHB 30AGHB 30YSHB 30GRHB 30GSHB 30MTHB 30OSHB 30BRHB 30MAHB</p>	<p>White Top Barnwood Top Black Top Blue Top Brushed Gunmetal Top Brushed Yellow Top Graphite Nebula Top Green Top Maple Top Orange Top Red Top Gray Acajou Top</p>	<p>Round: 30" Height: 45"</p>
 	<p>30" Round Bar Table w/ Standard Black Base</p>	<p>30WH42 30WDBB 30BKSB 30BEBB 30AGBB 30YBBB VTJ 30GSBB VTK 30OSBB VTB VTA</p>	<p>White Top Barnwood Top Black Top Blue Top Brushed Gunmetal Top Brushed Yellow Top Graphite Nebula Top Green Top Maple Top Orange Top Red Top Gray Acajou Top</p>	<p>Round: 30" Height: 42"</p>
	<p>30" Round Bar Table, Powered</p>	<p>P30BWH</p>	<p>White Top, Black</p>	<p>Round: 30" Height: 42"</p>







Product Image	Product Name	Product Code	Color/Materials	Dimensions
 	<p>36" Round Bar Table w/ Hydraulic Base</p>	<p>36WTHB 36BKHB 36GRHB 36MTHB</p>	<p>White Top Black Top Graphite Nebula Top Maple Top</p>	<p>Round: 36" Height: 45"</p>
 	<p>36" Round Bar Table w/ Standard Black Base</p>	<p>VTW 36BKSB VTN VTP</p>	<p>White Top Black Top Graphite Nebula Top Maple Top</p>	<p>Round: 36" Height: 42"</p>
 	<p>30" Round Cafe Table w/ Hydraulic Base</p>	<p>30WHHC 30WDHC 30BKHC 30BEHC 30AGHC 30YSHC 30GRHC 30GSHC 30MTHC 30OSHC 30BRHC 30MAHC</p>	<p>White Top Barnwood Top Black Top Blue Top Brushed Gunmetal Top Brushed Yellow Top Graphite Nebula Top Green Top Maple Top Orange Top Red Top Gray Acajou Top</p>	<p>Round: 30" Height: 29"</p>

Product Image	Product Name	Product Code	Color/Materials	Dimensions
 	<p>30" Round Cafe Table w/ Standard Black Base</p>	<p>30WH29 30WDBC 30BKSC 30BEBC 30AGBC 30YSBC ZTJ 30GSBC ZTK 30OSBC ZTB ZTA</p>	<p>White Top Barnwood Top Black Top Blue Top Brushed Gunmetal Top Brushed Yellow Top Graphite Nebula Top Green Top Maple Top Orange Top Red Top Gray Acajou Top</p>	<p>Round: 30" Height: 29"</p>
	<p>30" Round Cafe Table, Powered</p>	<p>P30CWH</p>	<p>White Top, Black</p>	<p>Round: 30" Height: 29"</p>
 	<p>36" Round Cafe Table w/ Hydraulic Base</p>	<p>36WTHC 36BKHC 36MTHC 36GRHC</p>	<p>White Top Black Top Maple Top Graphite Nebula Top</p>	<p>Round: 36" Height: 29"</p>









Product Image	Product Name	Product Code	Color/Materials	Dimensions
	<p>36" Round Cafe Table w/ Standard Black Base</p>	<p>ZTQ 36BKSC ZTN ZTP</p>	<p>White Top Black Top Graphite Nebula Top Maple Top</p>	<p>Round: 36" Height: 29"</p>
	<p>Rustique Square Metal Bar Table</p>	<p>RSTSQT</p>	<p>Gunmetal</p>	<p>Length: 23.75" Depth: 23.75" Height: 41.25"</p>









Product Image	Product Name	Product Code	Color/Materials	Dimensions
	Ventura Communal Bar Table	VNTBNP VNTWNP VNTMNP	Black Top, Silver White Top, Silver Maple Top, Silver	Length: 72.25" Depth: 26.25" Height: 42"
	Ventura Communal Bar Table, Powered	VNTBLK VNTWHT	Black Top, Silver White Top, Silver	Length: 72.25" Depth: 26.25" Height: 42"
	Ventura Communal Bar Table w/ Grommet Holes	VNTBWW VNTBMW	White Top, Silver Maple Top, Silver	Length: 72.25" Depth: 26.25" Height: 42"
	Ventura Communal Cafe Table	VNTCBN VNTCWN VNTCMN	Black Top, Silver White Top, Silver Maple Top, Silver	Length: 72.25" Depth: 26.25" Height: 30"
	Ventura Communal Cafe Table, Powered	VNTCBK VNTCWH	Black Top, Silver White Top, Silver	Length: 72.25" Depth: 26.25" Height: 30"
	Ventura Communal Cafe Table w/ Grommet Holes	VNTCWW VNTCMW	White Top, Silver Maple Top, Silver	Length: 72.25" Depth: 26.25" Height: 30"















Product Image	Product Name	Product Code	Color/Materials	Dimensions
	Adelaide Powered Cocktail Table	ADCTWP Non-Powered: ADCTWH	White Top, Silver	Length: 48.87" Depth: 25.37" Height: 18"
	Ventura Communal Bar Table, Powered	VNTBLK VNTWHT	Black Top, Silver White Top, Silver	Length: 72.25" Depth: 26.25" Height: 42"
	Ventura Communal Cafe Table, Powered	VNTCBK VNTCWH	Black Top, Silver White Top, Silver	Length: 72.25" Depth: 26.25" Height: 30"
	Village Charging Hub	VILHUB	Cream	Length: 12" Depth: 12" Height: 28.25"
	Wireless Charging Table	CUBPOW	White, AC Outlets	Length: 20" Depth: 20" Height: 18"
	30" Round Bar Table, Powered	P30BWH	White Top, Silver	Round: 30" Height: 42"















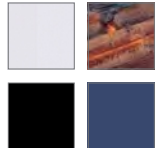





Product Image	Product Name	Product Code	Color/Materials	Dimensions
 	<p>10' Table</p>	<p>Powered: C10PWR Non-Powered: CONF10</p> <p>Powered: BKC10P Non-Powered: BKC10N</p> <p>Powered: M10PWR Non-Powered: MADC10</p> 	<p>White Top, Silver</p> <p>Black Top, Silver</p> <p>Gray Acajou, Silver</p>	<p>Length: 120" Depth: 48" Height: 29"</p>
 	<p>8' Table</p>	<p>Powered: C8PWR Non-Powered: CONF8</p> <p>Powered: BKCT8P Non-Powered: BKCT8N</p> <p>Powered: M8PWR Non-Powered: MADC08</p> 	<p>White Top, Silver</p> <p>Black Top, Silver</p> <p>Gray Acajou, Silver</p>	<p>Length: 96" Depth: 60" Height: 29"</p>
 	<p>5' Table</p>	<p>Powered: C5PWR Non-Powered: CONF5</p> <p>Powered: BKCT5P Non-Powered: BKCT5N</p> <p>Powered: M5PWR Non-Powered: MADC05</p> 	<p>White Top, Silver</p> <p>Black Top, Silver</p> <p>Gray Acajou, Silver</p>	<p>Length: 60" Depth: 48" Height: 29"</p>







Product Image	Product Name	Product Code	Color/Materials	Dimensions
 	<p>Adelaide Cocktail Table</p>	<p>Non-Powered: ADCTWH Powered: ADCTWP</p> <p>Non-Powered: ADCTBK Powered: ADCTBP</p> <p>ADCTGL</p> 	<p>White Top, Silver</p> <p>Black Top, Silver</p> <p>Glass Top, Silver</p>	<p>Length: 48.875" Depth: 25.375" Height: 18"</p>
 	<p>Adelaide End Table</p>	<p>ADETWH AETBK AETGL</p> 	<p>White Top, Silver Black Top, Silver Glass Top, Silver</p>	<p>Length: 21.5" Depth: 21.5" Height: 18"</p>
 	<p>Alondra Cocktail Table</p>	<p>ALC200</p> <p>ALC100</p> 	<p>Brandy Maple Top, Chrome</p> <p>Glass Top, Chrome</p>	<p>Length: 47" Depth: 24" Height: 17"</p> <p>Length: 47" Depth: 24" Height: 16"</p>







Product Image	Product Name	Product Code	Color/Materials	Dimensions
 	<p>Alondra End Table</p>	<p>ALE200 ALE100</p>	<p>Brandy Maple Top, Chrome Glass Top, Chrome</p>	<p>Length: 20" Depth: 20" Height: 21" Length: 20" Depth: 20" Height: 20"</p>
 	<p>Geo Cocktail Table</p>	<p>CIFWB CIC</p>	<p>Brandy Maple Top, Black Base Glass Top, Chrome Base</p>	<p>Length: 47" Depth: 24" Height: 17" Length: 50" Depth: 22" Height: 16"</p>
 	<p>Geo End Table</p>	<p>E1FWB E1C</p>	<p>Brandy Maple Top, Black Base Glass Top, Chrome Base</p>	<p>Length: 20" Depth: 20" Height: 21" Length: 24" Depth: 24" Height: 20"</p>







Product Image	Product Name	Product Code	Color/Materials	Dimensions
 	<p>Mesa Cocktail Table</p>	<p>MESCTW MESCTB MESCTG</p>	<p>Barnwood Top, Bronze Black Top, Bronze Glass Top, Bronze</p>	<p>Round: 32.25" Height: 17.25" Round: 36" Height: 17.25"</p>
 	<p>Mesa End Table</p>	<p>MESETW MESETB MESETG</p>	<p>Barnwood Top, Bronze Black Top, Bronze Glass Top, Bronze</p>	<p>Round: 20.5" Height: 21.25" Round: 24" Height: 21.25"</p>
	<p>Regis Bench/Table</p>	<p>REGBEN</p>	<p>Brushed Metal</p>	<p>Length: 47" Depth: 15.5" Height: 16"</p>
	<p>Regis End Table</p>	<p>REGOTT</p>	<p>Brushed Metal</p>	<p>Length: 16" Depth: 15.5" Height: 16.5"</p>





Product Image	Product Name	Product Code	Color/Materials	Dimensions
	<p>Silverado Cocktail Table</p> 	<p>C1E</p>	<p>Glass Top, Chrome</p>	<p>Round: 36" Height: 17"</p>
	<p>Silverado End Table</p> 	<p>E1E</p>	<p>Glass Top, Chrome</p>	<p>Round: 24" Height: 22"</p>
 	<p>Sydney Cocktail Table</p> 	<p>Non-Powered: C1W Powered: C1WP</p> <p>SYDWDC</p> <p>Non-Powered: C1Y Powered: C1YP</p> <p>SYDBEC</p>	<p>White Top, Brushed Steel</p> <p>Barnwood Top, Brushed Steel</p> <p>Black Top, Brushed Steel</p> <p>Blue Top, Brushed Steel</p>	<p>Length: 48" Depth: 26" Height: 18"</p>
 	<p>Sydney End Table</p> 	<p>E1W SYDWDE E1Y SYDBEE</p>	<p>White Top, Brushed Steel Barnwood Top, Brushed Steel Black Top, Brushed Steel Blue Top, Brushed Steel</p>	<p>Length: 27" Depth: 23" Height: 22"</p>







Product Image	Product Name	Product Code	Color/Materials	Dimensions
	<p>Aura Round Table</p> 	<p>AURA</p>	<p>White Metal</p>	<p>Round: 15" Height: 22"</p>
 	<p>Sedona Side Table</p> 	<p>SEDBWH SEDBWD SEDBBK</p>	<p>White Top, Bronze Barnwood Top, Bronze Black Top, Bronze</p>	<p>Length: 15.75" Depth: 15.75" Height: 24"</p>
 	<p>Taos Side Table</p> 	<p>TAOBWH TAOBWD TAOBK</p>	<p>White Top, Bronze Barnwood Top, Bronze Black Top, Bronze</p>	<p>Length: 15.75" Depth: 15.75" Height: 24"</p>
	<p>Timber Table</p>	<p>TMBTBL</p>	<p>Wood</p>	<p>Round: 16" Height: 17"</p>





Product Image	Product Name	Product Code	Color/Materials	Dimensions
	Madison Executive Desk	JD8	Gray Acajou	Length: 60" Depth: 30" Height: 29"
	Tech Desk, Powered	TECH	Black Metal, Black Laminate w/electrical unit	Length: 60" Depth: 30" Height: 30"
	Tech Desk, Powered w/ 3 Drawer File Cabinet	TECH3B	Black Metal, Black Laminate w/electrical unit	Length: 60" Depth: 30" Height: 30"
	3 Drawer File Cabinet on Castors	TECH3	Black Top, Black Metal	Length: 16" Depth: 20" Height: 28"
	Madison Bookcase	BC8	Gray Acajou	Length: 36" Depth: 12" Height: 72"
	Posh Shelving	PSHCCS	Chrome, Acrylic	Length: 36" Depth: 18" Height: 72"
	Divider, Freestanding Whiteboard	DIVFWB	Silver, White	Length: 39.5" Depth: 1.5" Height: 72"













Product Image	Product Name	Product Code	Color/Materials	Dimensions
	Atomic 42" Round Table	42ATO	Glass Top, Chrome	Round: 42" Height: 30"
	Atomic 36" Round Table	36ATO	Glass Top, Chrome	Round: 36" Height: 30"
	Geo Table, Rectangle	CF2 CE2	Glass Top, Black Glass Top, Chrome	Length: 60" Depth: 36" Height: 29"
	Geo Table, Rounded Square	CE1 CF1	Glass Top, Chrome Glass Top, Black	Length: 42" Depth: 42" Height: 29"
	Work Table	WD3	White Top, White	Length: 48" Depth: 24" Height: 30"
	42" Round Madison Table	CB8	Gray Acajou, Black	Round: 42" Height: 29"







Product Image	Product Name	Product Code	Color/Materials	Dimensions
	42" Round Table	CONF42	White Top, Black	Round: 42" Height: 29"
	42" Round Table	42BKCT	Black Top, Black	Round: 42" Height: 29"
	10' Table	Powered: BKC10P Non-Powered: BKC10N	Black Top, Silver	Length: 120" Depth: 48" Height: 29"
	8' Table	Powered: BKCT8P Non-Powered: BKCT8N	Black Top, Silver	Length: 96" Depth: 60" Height: 29"
	5' Table	Powered: BKCT5P Non-Powered: BKCT5N	Black Top, Silver	Length: 60" Depth: 48" Height: 29"
	10' Table	Powered: C10PWR Non-Powered: CONF10	White Top, Silver	Length: 120" Depth: 48" Height: 29"







Product Image	Product Name	Product Code	Color/Materials	Dimensions
	8' Table	Powered: C8PWR Non-Powered: CONF8	White Top, Silver	Length: 96" Depth: 60" Height: 29"
	5' Table	Powered: C5PWR Non-Powered: CONF5	White Top, Silver	Length: 60" Depth: 48" Height: 29"
	Madison 10' Table	Powered: M10PWR Non-Powered: MADC10	Gray Acajou, Silver	Length: 120" Depth: 48" Height: 29"
	Madison 8' Table	Powered: M8PWR Non-Powered: MADC08	Gray Acajou, Silver	Length: 96" Depth: 60" Height: 29"
	Madison 5' Table	Powered: M5PWR Non-Powered: MADC05	Gray Acajou, Silver	Length: 60" Depth: 48" Height: 29"

Product Image	Product Name	Product Code	Color/Materials	Dimensions
	Ace High Back Chair	ACEHBC	White Vinyl, Chrome	Length: 26" Depth: 26" Height: 42.25-44" Seat Length: 19.5" Seat Depth: 18" Seat Height: 17-19.75"
	Ace Mid Back Chair	ACEMBC	White Vinyl, Chrome	Length: 26" Depth: 26" Height: 33.25-33.75" Seat Length: 19.5" Seat Depth: 18" Seat Height: 17-19.75"
	Cupertino Mid Back Chair	CUPCHA	Black Vinyl, Chrome	Length: 27" Depth: 30.5" Height: 40-43" Seat Length: 19.5" Seat Depth: 19" Seat Height: 18.5-20.5"
	Genesis Chair	GENCHA	Black	Length: 27.5" Depth: 27.5" Height: 40-43.5" Seat Length: 20" Seat Depth: 17.5" Seat Height: 17.5-21"
	Pro Executive Guest Chair	PROGB	Black Vinyl, Chrome	Length: 24" Depth: 26" Height: 36" Seat Length: 19.5" Seat Depth: 19" Seat Height: 18"
	Pro Executive High Back Chair	PROEXB	Black Vinyl, Chrome	Length: 25" Depth: 24" Height: 45-48" Seat Length: 19.5" Seat Depth: 18.5" Seat Height: 18-21"

Product Image	Product Name	Product Code	Color/Materials	Dimensions
	Pro Executive High Back Chair	PROEXE	White Vinyl, Chrome	Length: 25" Depth: 24" Height: 45-48" Seat Length: 19.5" Seat Depth: 18.5" Seat Height: 18-21"
	Pro Executive Mid Back Chair	PROMDB	Black Vinyl, Chrome	Length: 24" Depth: 22" Height: 36.75-39.75" Seat Length: 20" Seat Depth: 19.5" Seat Height: 18-21"
	Pro Executive Mid Back Chair	PROMID	White Vinyl, Chrome	Length: 24" Depth: 22" Height: 36.75-39.75" Seat Length: 20" Seat Depth: 19.5" Seat Height: 18-21"
	Task Stool	TASKST	Black Fabric, Black	Length: 27.5" Depth: 27.5" Height: 32.75-40.25" Seat Length: 18.5" Seat Depth: 18.5" Seat Height: 18-25.5"

Product Image	Product Name	Product Code	Color/Materials	Dimensions
	Midtown Powered Counter, Lighted w/ Plug In 	MTCLPI	Taupe Glass Top, Pewter	Length: 60" Depth: 18" Height: 42"
	Midtown Powered Counter, Unlighted 	MTCPUL	Taupe Glass Top, Pewter	Length: 60" Depth: 18" Height: 42"
	Powered Locking Pedestal, 36" 	PDL36B	Black	Length: 24" Depth: 24" Height: 36"
	Powered Locking Pedestal, 36" 	PDL36W	White	Length: 24" Depth: 24" Height: 36"
	Powered Locking Pedestal, 42" 	PDL42B	Black	Length: 24" Depth: 24" Height: 42"
	Powered Locking Pedestal, 42" 	PDL42W	White	Length: 24" Depth: 24" Height: 42"

Product Image	Product Name	Product Code	Color/Materials	Dimensions
	Clear Divider, Bar/Counter	DIVBAR	Clear, Black	Length: 48-70" Depth: 12" Height: 31.5"
	Clear Divider, Freestanding	DIVFRE	Silver, Clear	Length: 39" Depth: 1.5" Height: 72"
	Clear Divider, Freestanding Corner	DIVFCR	Silver, Clear	Length: 39" Depth: 39" Height: 72"
	Clear Divider, Freestanding Wall	DIVFWL	Silver, Clear	Length: 40" Depth: 1.5" Height: 72"
	Clear Divider, Sofa/Table	DIVFST	Silver, Clear	Length: 34" Depth: 11" Height: 47-74"
	Miramar Divider, White	MIRWHT	Molded Plastic	Length: 63" Depth: 23" Height: 83"

Product Image	Product Name	Product Code	Color/Materials	Dimensions
	Stanchion Sign Holder	STNSGN	Chrome	Length: 10" Height: 13"
	Stanchion w/ Retractable Belt	STNCH1	Black, Chrome	Length: 96" Height: 37"
	Mason Floor Lamp	LA15	Brushed Silver	Round: 18" Height: 55"
	Mason Table Lamp	LA14	Brushed Silver	Round: 16" Height: 26"
	Boxwood Hedge 7'	HDG7FT	Green, Black	Length: 36.5" Depth: 12" Height: 84"
	Boxwood Hedge 4'	HDG4FT	Green, Black	Length: 46" Depth: 9" Height: 47"

SOFT SEATING COLLECTIONS

NGAUS General Conference & Exhibition

I138120824

Huntington Place | Detroit, MI

August 24 - 26, 2024

ONLINE & DISCOUNT DEADLINE:* FRIDAY, AUGUST 2, 2024

* Order with complete Method of Payment must be received before Discount Deadline date to receive discounted pricing.

Loveseats

CODE	ITEM	QTY	ONLINE	DISCOUNT	REGULAR	TOTAL
BLVWHT	Baja Loveseat - White Vinyl, Metal Base		\$1,476.85	\$1,698.40	\$1,902.20	
KEYLOV	Key Largo Loveseat - Black Fabric, Metal Base		\$680.30	\$782.35	\$876.25	
NPLLOV	Naples Loveseat - Black Vinyl, Metal Base		\$1,304.05	\$1,499.65	\$1,679.60	
NPLLOP	Naples Loveseat - Black Vinyl, Metal Base POWERED		\$1,625.00	\$1,868.75	\$2,093.00	
COLVTP	Cordoba Loveseat - Taupe, Black Metal Base		\$1,043.90	\$1,200.50	\$1,344.55	
MONLOV	Montreal Loveseat - Blue, Black Metal Base		\$1,253.20	\$1,441.20	\$1,614.15	

Sofas

CODE	ITEM	QTY	ONLINE	DISCOUNT	REGULAR	TOTAL
SFA002	Allegro Sofa - Blue Fabric, Brushed Metal		\$1,297.15	\$1,491.70	\$1,670.70	
BSFWHT	Baja Sofa - White Vinyl		\$1,570.10	\$1,805.60	\$2,022.25	
FAIRSW	Fairfax Sofa - White Vinyl, Brushed Metal		\$884.70	\$1,017.40	\$1,139.50	
KEYSOF	Key Largo Sofa - Black Fabric, Wood		\$877.65	\$1,009.30	\$1,130.40	
NPLSOF	Naples Sofa - Black Vinyl		\$1,550.90	\$1,783.55	\$1,997.60	
NPLLOP	Naples Sofa - Black Vinyl POWERED		\$1,889.30	\$2,172.70	\$2,433.40	
PALSOF	Palm Beach Sofa - White Vinyl		\$1,231.95	\$1,416.75	\$1,586.75	
STESOF	Sterling Sofa - Grey Fabric		\$1,462.55	\$1,681.95	\$1,883.80	
VALSOF	Valencia Sofa - Coffee Brown Velvet		\$825.35	\$949.15	\$1,063.05	

= **Electrical Power** (Client is responsible for providing labor and an electrical power source to the furniture.)
 NOTE: Items may be discontinued without notice at any time.

TOTAL ESTIMATE	\$ _____
TAX (All tax rates are subject to change)	6.00%
AMOUNT DUE	\$ _____

Submission of this form indicates you read and accept the Payment Policy and Terms & Conditions. There are no exchanges or refunds once item has been delivered to your booth. Cancellations must be received in writing 14 days prior to first exhibitor move in day. Rental items found and in use in your booth are subject to "Regular" pricing.

COMPANY NAME: _____ BOOTH NUMBER: _____

CONTACT NAME: _____

EMAIL ADDRESS: _____



Email completed form to: orders@shepardes.com

ACCENT CHAIRS

NGAUS General Conference & Exhibition

I138120824

Huntington Place | Detroit, MI

August 24 - 26, 2024

ONLINE & DISCOUNT DEADLINE:* FRIDAY, AUGUST 2, 2024

* Order with complete Method of Payment must be received before Discount Deadline date to receive discounted pricing.

CODE	ITEM	QTY	ONLINE	DISCOUNT	REGULAR	TOTAL
CHR002	Allegro Chair - Blue Fabric, Brushed Metal		\$910.00	\$1,046.50	\$1,172.10	
ATHCHA	Atherton Chair - Brown Leather, Black Metal		\$754.20	\$867.35	\$971.45	
BCHWHT	Baja Chair - White Vinyl		\$1,008.15	\$1,159.35	\$1,298.45	
BOWCHA	Bowery Chair - Ochre Fabric		\$708.35	\$814.60	\$912.35	
CNTCHR	Century Chair - Gray Velvet		\$721.90	\$830.20	\$929.80	
FAIRCW	Fairfax Chair - White Vinyl, Brushed Metal		\$638.00	\$733.70	\$821.75	
KEYCHR	Key Largo Chair - Black Fabric, Wood		\$581.60	\$668.85	\$749.10	
LABREA	La Brea Swivel Chair - Charcoal Gray Fabric, Chrome		\$761.30	\$875.50	\$980.55	
LENCHA	Lena Chair - Moss Green Leather, Bronze		\$635.70	\$731.05	\$818.80	
BCW	Madrid Chair - White Vinyl, Chrome		\$1,385.30	\$1,593.10	\$1,784.25	
MONCHA	Montreal Chair - Blue, Black Metal		\$778.45	\$895.20	\$1,002.60	
MNCHCH	Munich Armless Chair - Gray Fabric, Black		\$1,046.85	\$1,203.90	\$1,348.35	
NPLCHP	Naples Chair - Black Vinyl  POWERED		\$1,173.75	\$1,349.80	\$1,511.80	
NPLCHR	Naples Chair - Black Vinyl		\$1,082.10	\$1,244.40	\$1,393.75	
STECHA	Sterling Chair - Gray Fabric		\$1,004.65	\$1,155.35	\$1,294.00	
SWAN	Swanson Swivel Chair - White Vinyl, Chrome		\$662.60	\$762.00	\$853.45	
TCHP	Tech Chair, No Tablet - Gray Vinyl, Chrome Base		\$554.85	\$638.10	\$714.65	
TCHGRY	Tech Tablet Chair - Gray Vinyl, White Metal Tablet, Chrome Base  POWERED		\$541.40	\$622.60	\$697.30	
VALCHA	Valencia Chair - Spice Orange Velvet		\$555.30	\$638.60	\$715.25	
WENCHA	Wentworth Swivel Chair - Brown Vinyl		\$608.85	\$700.20	\$784.20	
BNMCOW	Brooklyn Meeting Chair - White		\$487.35	\$560.45	\$627.70	
BNMCSW	Brooklyn Meeting Chair, Swivel - White		\$487.35	\$560.45	\$627.70	
BNMCSB	Brooklyn Meeting Chair - Black		\$457.60	\$526.25	\$589.40	
BNMCOB	Brooklyn Meeting Chair, Swivel - Black		\$457.60	\$526.25	\$589.40	
COCHTP	Cordoba Chair		\$731.00	\$840.65	\$941.55	

 = **Electrical Power** (Client is responsible for providing labor and an electrical power source to the furniture.)

NOTE: Items may be discontinued without notice at any time.

TOTAL ESTIMATE	\$ _____
TAX (All tax rates are subject to change)	6.00%
AMOUNT DUE	\$ _____

Submission of this form indicates you read and accept the Payment Policy and Terms & Conditions. There are no exchanges or refunds once item has been delivered to your booth. Cancellations must be received in writing 14 days prior to first exhibitor move in day. Rental items found and in use in your booth are subject to "Regular" pricing.

COMPANY NAME: _____ BOOTH NUMBER: _____

CONTACT NAME: _____

EMAIL ADDRESS: _____



Email completed form to: orders@shepardes.com

shepardes.com

INDIVIDUAL SEATING

NGAUS General Conference & Exhibition
 Huntington Place | Detroit, MI
 August 24 - 26, 2024

I138120824

ONLINE & DISCOUNT DEADLINE:* FRIDAY, AUGUST 2, 2024

* Order with complete Method of Payment must be received before Discount Deadline date to receive discounted pricing.

CODE	ITEM	QTY	ONLINE	DISCOUNT	REGULAR	TOTAL
BLDCRD	Blade Chair - Red		\$124.95	\$143.70	\$160.95	
BLDCSB	Blade Chair - Sky Blue		\$124.95	\$143.70	\$160.95	
BLDCBK	Blade Chair - Black		\$106.60	\$122.60	\$137.30	
CCSCAZ	Chelsea Chair - Azure Blue, Black Swivel Base		\$241.80	\$278.05	\$311.40	
CCBTAZ	Chelsea Chair - Azure Blue, Black Tower Base		\$241.80	\$278.05	\$311.40	
CCSCBK	Chelsea Chair - Black, Black Swivel Base		\$241.80	\$278.05	\$311.40	
CCBTBK	Chelsea Chair - Black, Black Tower Base		\$241.80	\$278.05	\$311.40	
CCSCYL	Chelsea Chair - Goldenrod Yellow, Black Swivel Base		\$241.80	\$278.05	\$311.40	
CCBTYL	Chelsea Chair - Goldenrod Yellow, Black Tower Base		\$241.80	\$278.05	\$311.40	
CCSCGY	Chelsea Chair - Gray, Black Swivel Base		\$241.80	\$278.05	\$311.40	
CCBTGY	Chelsea Chair - Gray, Black Tower Base		\$241.80	\$278.05	\$311.40	
CCSCOR	Chelsea Chair - Orange, Black Swivel Base		\$241.80	\$278.05	\$311.40	
CCBTOR	Chelsea Chair - Orange, Black Tower Base		\$241.80	\$278.05	\$311.40	
CCSCWL	Chelsea Chair - Walnut, Black Swivel Base		\$241.80	\$278.05	\$311.40	
CCBTWL	Chelsea Chair - Walnut, Black Tower Base		\$241.80	\$278.05	\$311.40	
SC3	Brewer Chair - Onyx, Chrome		\$324.15	\$372.75	\$417.50	
XCHR	Christopher Chair - White Vinyl, Chrome		\$193.90	\$223.00	\$249.75	
DUET	Duet Stack Chair - Black, Chrome		\$119.85	\$137.85	\$154.40	
LMCHR	Laguna Chair - Maple, Chrome		\$274.95	\$316.20	\$354.15	
LUCHCL	Lucent Chair - Frosted Acrylic, Chrome		\$336.45	\$386.90	\$433.35	
MALGRN	Malba Chair - Green, Chrome		\$211.50	\$243.25	\$272.45	
MALGRY	Malba Chair - Gray, Chrome		\$211.50	\$243.25	\$272.45	
MARCBE	Marina Chair - Ocean Blue Fabric, Brushed Metal		\$272.35	\$313.20	\$350.80	
MARCBK	Marina Chair - Black Vinyl, Brushed Metal		\$272.35	\$313.20	\$350.80	
MARCBR	Marina Chair - Brown Fabric, Brushed Metal		\$272.35	\$313.20	\$350.80	
MARCRD	Marina Chair - Red Fabric, Brushed Metal		\$272.35	\$313.20	\$350.80	
MARCWH	Marina Chair - White Vinyl, Brushed Metal		\$272.35	\$313.20	\$350.80	
PASCHR	Pasadena Chair - White Molded Plastic w/Chrome Tower Base		\$439.00	\$504.85	\$565.45	
SC10	Razor Armless Chair - White		\$144.55	\$166.25	\$186.20	
RSTDIN	Rustique Chair w/ Arms - Gunmetal		\$243.15	\$279.60	\$313.15	
CS4	Syntax Chair - Black, Chrome		\$384.20	\$441.85	\$494.85	
ZENCHR	Zenith Chair - White, Chrome		\$310.10	\$356.60	\$399.40	

NOTE: Items may be discontinued without notice at any time.

TOTAL ESTIMATE	\$ _____
TAX (All tax rates are subject to change)	6.00%
AMOUNT DUE	\$ _____

Submission of this form indicates you read and accept the Payment Policy and Terms & Conditions. There are no exchanges or refunds once item has been delivered to your booth. Cancellations must be received in writing 14 days prior to first exhibitor move in day. Rental items found and in use in your booth are subject to "Regular" pricing.

COMPANY NAME: _____ BOOTH NUMBER: _____

CONTACT NAME: _____

EMAIL ADDRESS: _____



Email completed form to: orders@shepardes.com

shepardes.com

BENCHES & OTTOMANS

NGAUS General Conference & Exhibition

I138120824

Huntington Place | Detroit, MI

August 24 - 26, 2024

ONLINE & DISCOUNT DEADLINE:* FRIDAY, AUGUST 2, 2024

* Order with complete Method of Payment must be received before Discount Deadline date to receive discounted pricing.

Beverly Benches

CODE	ITEM	QTY	ONLINE	DISCOUNT	REGULAR	TOTAL
BVSMBK	Beverly Small Bench Ottoman - Black Vinyl		\$390.60	\$449.20	\$503.10	
BVSMBL	Beverly Small Bench Ottoman - Ocean Blue Fabric		\$390.60	\$449.20	\$503.10	
BVSMBN	Beverly Small Bench Ottoman - Brown Fabric		\$390.60	\$449.20	\$503.10	
BVSMGN	Beverly Small Bench Ottoman - Olive Green Fabric		\$390.60	\$449.20	\$503.10	
BVSMCY	Beverly Small Bench Ottoman - Grey Fabric		\$390.60	\$449.20	\$503.10	
BVSM LN	Beverly Small Bench Ottoman - Linen Fabric		\$390.60	\$449.20	\$503.10	
BVSM LV	Beverly Small Bench Ottoman - Lavender Fabric		\$390.60	\$449.20	\$503.10	
BVSMOR	Beverly Small Bench Ottoman - Orange Fabric		\$390.60	\$449.20	\$503.10	
BVSMRD	Beverly Small Bench Ottoman - Red Fabric		\$390.60	\$449.20	\$503.10	
BVSMWH	Beverly Small Bench Ottoman - White Vinyl		\$390.60	\$449.20	\$503.10	
BVSMYL	Beverly Small Bench Ottoman - Yellow Fabric		\$390.60	\$449.20	\$503.10	
BVLYBK	Beverly Bench - Black Vinyl		\$747.25	\$859.35	\$962.45	
BVLYBN	Beverly Bench - Brown Fabric		\$747.25	\$859.35	\$962.45	
BVLYGR	Beverly Bench - Grey Fabric		\$747.25	\$859.35	\$962.45	
BVLYLN	Beverly Bench - Linen Fabric		\$747.25	\$859.35	\$962.45	
BVLYOB	Beverly Bench - Ocean Fabric		\$747.25	\$859.35	\$962.45	
BVLYRD	Beverly Bench - Red Fabric		\$747.25	\$859.35	\$962.45	
BVLYWH	Beverly Bench - White Vinyl		\$747.25	\$859.35	\$962.45	

Metal Bench

CODE	ITEM	QTY	ONLINE	DISCOUNT	REGULAR	TOTAL
RECBEN	Regis Bench/Table - Brushed Metal		\$532.20	\$612.05	\$685.50	

Ottomans

CODE	ITEM	QTY	ONLINE	DISCOUNT	REGULAR	TOTAL
END01B	Endless Curved Ottoman - Black Vinyl, Chrome		\$775.45	\$891.75	\$998.75	
END01W	Endless Curved Ottoman - White Vinyl, Chrome		\$775.45	\$891.75	\$998.75	
END02B	Endless Square Ottoman - Black Vinyl, Chrome		\$486.45	\$559.40	\$626.55	
END02W	Endless Square Ottoman - White Vinyl, Chrome		\$486.45	\$559.40	\$626.55	

NOTE: Items may be discontinued without notice at any time.

TOTAL ESTIMATE	\$ _____
TAX (All tax rates are subject to change)	6.00%
AMOUNT DUE	\$ _____

Submission of this form indicates you read and accept the Payment Policy and Terms & Conditions. There are no exchanges or refunds once item has been delivered to your booth. Cancellations must be received in writing 14 days prior to first exhibitor move in day. Rental items found and in use in your booth are subject to "Regular" pricing.

COMPANY NAME: _____ BOOTH NUMBER: _____

CONTACT NAME: _____

EMAIL ADDRESS: _____



Email completed form to: orders@shepardes.com

CUBE & SWIVEL OTTOMANS

NGAUS General Conference & Exhibition

I138120824

Huntington Place | Detroit, MI

August 24 - 26, 2024

ONLINE & DISCOUNT DEADLINE:* FRIDAY, AUGUST 2, 2024

* Order with complete Method of Payment must be received before Discount Deadline date to receive discounted pricing.

Vibe Cubes

CODE	ITEM	QTY	ONLINE	DISCOUNT	REGULAR	TOTAL
VIB01	Vibe Cube - Green		\$260.90	\$300.05	\$336.05	
VIB02	Vibe Cube - Blue		\$260.90	\$300.05	\$336.05	
VIB04	Vibe Cube - Red		\$260.90	\$300.05	\$336.05	
VIB05	Vibe Cube - Yellow		\$260.90	\$300.05	\$336.05	
VIB08	Vibe Cube - Orange		\$260.90	\$300.05	\$336.05	
VIB09	Vibe Cube - White Waterproof		\$260.90	\$300.05	\$336.05	
VIB10	Vibe Cube - Black Waterproof		\$260.90	\$300.05	\$336.05	
VIB11	Vibe Cube - Steel Blue Vinyl		\$260.90	\$300.05	\$336.05	
VIB12	Vibe Cube - Silver Vinyl		\$260.90	\$300.05	\$336.05	
VIB13	Vibe Cube - Purple Vinyl		\$260.90	\$300.05	\$336.05	
VIB14	Vibe Cube - Cirtus Green		\$260.90	\$300.05	\$336.05	
VIB15	Vibe Cube - Taupe Vinyl		\$260.90	\$300.05	\$336.05	
VIB16	Vibe Cube - Spice Orange		\$260.90	\$300.05	\$336.05	
VIB17	Vibe Cube - Desert Rose		\$260.90	\$300.05	\$336.05	

Marche Swivel

CODE	ITEM	QTY	ONLINE	DISCOUNT	REGULAR	TOTAL
MAR001	Marche Swivel - White		\$345.35	\$397.15	\$444.80	
MAR002	Marche Swivel - Grey		\$345.35	\$397.15	\$444.80	
MAR003	Marche Swivel - Linen		\$345.35	\$397.15	\$444.80	
MAR004	Marche Swivel - Raspberry		\$345.35	\$397.15	\$444.80	
MAR005	Marche Swivel - Red		\$345.35	\$397.15	\$444.80	
MAR006	Marche Swivel - Rose Qtz		\$345.35	\$397.15	\$444.80	
MAR007	Marche Swivel - Plum		\$345.35	\$397.15	\$444.80	
MAR008	Marche Swivel - Meadow Green		\$345.35	\$397.15	\$444.80	
MAR009	Marche Swivel - Pear		\$345.35	\$397.15	\$444.80	
MAR010	Marche Swivel - Blue		\$345.35	\$397.15	\$444.80	
MAR011	Marche Swivel - Orange		\$345.35	\$397.15	\$444.80	
MAR012	Marche Swivel - Forest Green		\$345.35	\$397.15	\$444.80	
MAR013	Marche Swivel - Teal Velvet		\$345.35	\$397.15	\$444.80	
MAR014	Marche Swivel - Distressed Brown		\$345.35	\$397.15	\$444.80	
MAR015	Marche Swivel - Black Vinyl		\$345.35	\$397.15	\$444.80	
MAR016	Marche Swivel - Ivory Faux Sheep Fur		\$345.35	\$397.15	\$444.80	

NOTE: Items may be discontinued without notice at any time.

TOTAL ESTIMATE	\$ _____
TAX (All tax rates are subject to change)	6.00%
AMOUNT DUE	\$ _____

Submission of this form indicates you read and accept the Payment Policy and Terms & Conditions. There are no exchanges or refunds once item has been delivered to your booth. Cancellations must be received in writing 14 days prior to first exhibitor move in day. Rental items found and in use in your booth are subject to "Regular" pricing.

COMPANY NAME: _____ BOOTH NUMBER: _____

CONTACT NAME: _____

EMAIL ADDRESS: _____



Email completed form to: orders@shepardes.com

ORDER ONLINE!

ACCENT TABLES: COCKTAIL & END

NGAUS General Conference & Exhibition
Huntington Place | Detroit, MI
August 24 - 26, 2024

I138120824

ONLINE & DISCOUNT DEADLINE:* FRIDAY, AUGUST 2, 2024

* Order with complete Method of Payment must be received before Discount Deadline date to receive discounted pricing.

Cocktail Tables

CODE	ITEM	QTY	ONLINE	DISCOUNT	REGULAR	TOTAL
ADCTBK	Adelaide Cocktail Table - Black Top, Silver		\$405.60	\$466.45	\$522.40	
ADCTGL	Adelaide Cocktail Table - Glass Top, Silver		\$405.60	\$466.45	\$522.40	
ADCTWH	Adelaide Cocktail Table - White Top, Silver		\$405.60	\$466.45	\$522.40	
ADCTBP	Adelaide Cocktail Table - Black Top, Silver  POWERED		\$561.60	\$645.85	\$723.35	
ADCTWP	Adelaide Cocktail Table - White Top, Silver  POWERED		\$561.60	\$645.85	\$723.35	
ALC100	Alondra Cocktail Table - Glass Top, Chrome		\$620.30	\$713.35	\$798.95	
ALC200	Alondra Cocktail Table - Brandy Maple Top, Chrome		\$620.30	\$713.35	\$798.95	
CIC	Geo Cocktail Table - Glass Top, Chrome		\$465.25	\$535.05	\$599.25	
CIFWB	Geo Cocktail Table - Brandy Maple Top, Black		\$542.80	\$624.20	\$699.10	
MESCTB	Mesa Cocktail Table - Black Top, Bronze		\$359.30	\$413.20	\$462.80	
MESCTG	Mesa Cocktail Table - Glass Top, Bronze		\$359.30	\$413.20	\$462.80	
MESCTW	Mesa Cocktail Table - Barnwood Top, Bronze		\$359.30	\$413.20	\$462.80	
CIE	Silverado Cocktail Table - Glass Top, Chrome		\$514.60	\$591.80	\$662.80	
CIW	Sydney Cocktail Table - White Top, Brushed Steel		\$521.65	\$599.90	\$671.90	
CIY	Sydney Cocktail Table - Black Top, Brushed Steel		\$521.65	\$599.90	\$671.90	
CIWP	Sydney Cocktail Table - White Top, Brushed Steel  POWERED		\$662.60	\$762.00	\$853.45	
CIYP	Sydney Cocktail Table - Black Top, Brushed Steel  POWERED		\$662.60	\$762.00	\$853.45	
SYDBEC	Sydney Cocktail Table - Blue Top, Brushed Steel		\$528.70	\$608.00	\$680.95	
SYDWDC	Sydney Cocktail Table - Barnwood Top, Brushed Steel		\$480.60	\$552.70	\$619.00	

Submission of this form indicates you read and accept the Payment Policy and Terms & Conditions. There are no exchanges or refunds once item has been delivered to your booth. Cancellations must be received in writing 14 days prior to first exhibitor move in day. Rental items found and in use in your booth are subject to "Regular" pricing.

TOTAL ESTIMATE	\$ _____
TAX (All tax rates are subject to change)	6.00%
AMOUNT DUE	\$ _____

COMPANY NAME: _____ BOOTH NUMBER: _____

CONTACT NAME: _____

EMAIL ADDRESS: _____



Email completed form to: orders@shepardes.com

shepardes.com

ACCENT TABLES: SIDE

NGAUS General Conference & Exhibition

I138120824

Huntington Place | Detroit, MI

August 24 - 26, 2024

ONLINE & DISCOUNT DEADLINE:* FRIDAY, AUGUST 2, 2024

* Order with complete Method of Payment must be received before Discount Deadline date to receive discounted pricing.

End Tables

CODE	ITEM	QTY	ONLINE	DISCOUNT	REGULAR	TOTAL
ADETBK	Adelaide End Table - Black Top, Silver		\$392.60	\$451.50	\$505.70	
ADETGL	Adelaide End Table - Glass Top, Silver		\$392.60	\$451.50	\$505.70	
ADETWH	Adelaide End Table - White Top, Silver		\$392.60	\$451.50	\$505.70	
ALE100	Alondra End Table - Glass Top, Chrome		\$447.65	\$514.80	\$576.60	
ALE200	Alondra End Table - Brandy Maple Top, Chrome		\$447.65	\$514.80	\$576.60	
CUBPOW	Wireless Charging Table - White, AC Plug In  POWERED		\$797.90	\$917.60	\$1,027.70	
ETC	Geo End Table - Glass Top, Chrome		\$458.25	\$527.00	\$590.25	
EIFWB	Geo End Table - Brandy Maple Top, Black		\$472.30	\$543.15	\$608.35	
MESETB	Mesa End Table - Black Top, Bronze		\$237.40	\$273.00	\$305.75	
MESETG	Mesa End Table - Glass Top, Bronze		\$237.40	\$273.00	\$305.75	
MESETW	Mesa End Table - Barnwood Top, Bronze		\$237.40	\$273.00	\$305.75	
REGOTT	Regis End Table - Brushed Metal		\$391.30	\$450.00	\$504.00	
EIE	Silverado End Table - Glass, Chrome		\$489.90	\$563.40	\$631.00	
EIW	Sydney End Table - White Top, Brushed Steel		\$472.30	\$543.15	\$608.35	
ETY	Sydney End Table - Black Top, Brushed Steel		\$472.30	\$543.15	\$608.35	
SYDBEE	Sydney End Table - Blue Top, Brushed Steel		\$464.60	\$534.30	\$598.40	
SYDWDE	Sydney End Table - Barnwood Top, Brushed Steel		\$464.60	\$534.30	\$598.40	

 = **Electrical Power** (Client is responsible for providing labor and an electrical power source to the furniture.)

NOTE: Items may be discontinued without notice at any time.

Side Tables

CODE	ITEM	QTY	ONLINE	DISCOUNT	REGULAR	TOTAL
AURA	Aura Round Table - White Metal		\$267.80	\$307.95	\$344.90	
SEDBBK	Sedona Side Table - Black Top, Bronze		\$239.55	\$275.50	\$308.55	
SEDBWD	Sedona Side Table - Wood Top, Bronze		\$239.55	\$275.50	\$308.55	
SEDBWH	Sedona Side Table - White Top, Bronze		\$239.55	\$275.50	\$308.55	
TAOBBK	Taos Side Table - Black Top, Bronze		\$239.55	\$275.50	\$308.55	
TAOBWD	Taos Side Table - Wood Top, Bronze		\$239.55	\$275.50	\$308.55	
TAOBWH	Taos Side Table - White Top, Bronze		\$239.55	\$275.50	\$308.55	
TMBTBL	Timber Table - Wood		\$317.25	\$364.85	\$408.65	

NOTE: Items may be discontinued without notice at any time.

TOTAL ESTIMATE	\$ _____
TAX (All tax rates are subject to change)	6.00%
AMOUNT DUE	\$ _____

Submission of this form indicates you read and accept the Payment Policy and Terms & Conditions. There are no exchanges or refunds once item has been delivered to your booth. Cancellations must be received in writing 14 days prior to first exhibitor move in day. Rental items found and in use in your booth are subject to "Regular" pricing.

COMPANY NAME: _____ BOOTH NUMBER: _____

CONTACT NAME: _____

EMAIL ADDRESS: _____



Email completed form to: orders@shepardes.com

shepardes.com

BAR TABLES, BARS & COUNTERS

NGAUS General Conference & Exhibition

I138120824

Huntington Place | Detroit, MI

August 24 - 26, 2024

ONLINE & DISCOUNT DEADLINE:* FRIDAY, AUGUST 2, 2024

* Order with complete Method of Payment must be received before Discount Deadline date to receive discounted pricing.

30" Round Bar Table with Black Base

CODE	ITEM	QTY	ONLINE	DISCOUNT	REGULAR	TOTAL
30AGBB	30" Round Bar Table w/ Standard Black Base - Brushed Gunmetal Top		\$464.60	\$534.30	\$598.40	
30BEBB	30" Round Bar Table w/ Standard Black Base - Blue Top		\$464.60	\$534.30	\$598.40	
30BKSB	30" Round Bar Table w/ Standard Black Base - Black Top		\$464.60	\$534.30	\$598.40	
30GSBB	30" Round Bar Table w/ Standard Black Base - Green Top		\$464.60	\$534.30	\$598.40	
30OSBB	30" Round Bar Table w/ Standard Black Base - Orange Top		\$464.60	\$534.30	\$598.40	
30WDBB	30" Round Bar Table w/ Standard Black Base - Barnwood Top		\$464.60	\$534.30	\$598.40	
30WH42	30" Round Bar Table w/ Standard Black Base - White Top		\$482.80	\$555.20	\$621.80	
30YBBB	30" Round Bar Table w/ Standard Black Base - Brushed Yellow Top		\$464.60	\$534.30	\$598.40	
VTB	30" Round Bar Table w/ Standard Black Base - Red Top		\$458.25	\$527.00	\$590.25	
VTJ	30" Round Bar Table w/ Standard Black Base - Graphite Nebula Top		\$458.25	\$527.00	\$590.25	
VTK	30" Round Bar Table w/ Standard Black Base - Maple Top		\$458.25	\$527.00	\$590.25	
VTA	30" Round Madison Bar Table w/ Standard Black Base - Gray Acajou Top		\$458.25	\$527.00	\$590.25	
P30BWH	30" Round Cafe Table w/ Standard Black Base - White Top  POWERED		\$938.65	\$1,079.45	\$1,209.00	

36" Round Bar Table with Black Base

CODE	ITEM	QTY	ONLINE	DISCOUNT	REGULAR	TOTAL
36BKSB	36" Round Bar Table w/ Standard Black Base - Black Top		\$458.25	\$527.00	\$590.25	
VTN	36" Round Bar Table w/ Standard Black Base - Graphite Nebula Top		\$489.90	\$563.40	\$631.00	
VTW	36" Round Bar Table w/ Standard Black Base - White Top		\$489.90	\$563.40	\$631.00	
VTP	36" Round Bar Table w/ Standard Black Base - Maple Top		\$489.90	\$563.40	\$631.00	

30" Round Bar Table with Hydraulic Base

CODE	ITEM	QTY	ONLINE	DISCOUNT	REGULAR	TOTAL
30AGHB	30" Round Bar Table w/ Hydraulic Base - Brushed Gunmetal Top		\$560.80	\$644.90	\$722.30	
30BEHB	30" Round Bar Table w/ Hydraulic Base - Blue Top		\$560.80	\$644.90	\$722.30	
30BKHB	30" Round Bar Table w/ Hydraulic Base - Black Top		\$560.80	\$644.90	\$722.30	
30BRHB	30" Round Bar Table w/ Hydraulic Base - Red Top		\$556.90	\$640.45	\$717.30	
30GRHB	30" Round Bar Table w/ Hydraulic Base - Graphite Nebula Top		\$556.90	\$640.45	\$717.30	
30GSHB	30" Round Bar Table w/ Hydraulic Base - Green Top		\$560.80	\$644.90	\$722.30	
30MTHB	30" Round Bar Table w/ Hydraulic Base - Maple Top		\$606.25	\$697.20	\$780.85	
30OSHB	30" Round Bar Table w/ Hydraulic Base - Orange Top		\$560.80	\$644.90	\$722.30	
30WDHB	30" Round Bar Table w/ Hydraulic Base - Barnwood Top		\$560.80	\$644.90	\$722.30	
30WHHB	30" Round Bar Table w/ Hydraulic Base - White Top		\$602.80	\$693.20	\$776.40	
30YSHB	30" Round Bar Table w/ Hydraulic Base - Brushed Yellow Top		\$560.80	\$644.90	\$722.30	
30MAHB	30" Round Madison Bar Table w/ Hydraulic Base - Gray Acajou Top		\$556.90	\$640.45	\$717.30	

36" Round Bar Table with Hydraulic Base

CODE	ITEM	QTY	ONLINE	DISCOUNT	REGULAR	TOTAL
36BKHB	36" Round Bar Table w/ Hydraulic Base - Black Top		\$560.80	\$644.90	\$722.30	
36GRHB	36" Round Bar Table w/ Hydraulic Base - Graphite Nebula Top		\$606.25	\$697.20	\$780.85	
36MTHB	36" Round Bar Table w/ Hydraulic Base - Maple Top		\$606.25	\$697.20	\$780.85	
36WTHB	36" Round Bar Table w/ Hydraulic Base - White Top		\$606.25	\$697.20	\$780.85	

BAR TABLES, BARS & COUNTERS CONTINUED

NGAUS General Conference & Exhibition
 Huntington Place | Detroit, MI
 August 24 - 26, 2024

I138120824

ONLINE & DISCOUNT DEADLINE:* FRIDAY, AUGUST 2, 2024

* Order with complete Method of Payment must be received before Discount Deadline date to receive discounted pricing.

30" Round Bar Table with Black Base

CODE	ITEM	QTY	ONLINE	DISCOUNT	REGULAR	TOTAL
30AGBB	30" Round Bar Table w/ Standard Black Base - Brushed Gunmetal Top		\$464.60	\$534.30	\$598.40	
30BEBB	30" Round Bar Table w/ Standard Black Base - Blue Top		\$464.60	\$534.30	\$598.40	
30BKSB	30" Round Bar Table w/ Standard Black Base - Black Top		\$464.60	\$534.30	\$598.40	
30GSBB	30" Round Bar Table w/ Standard Black Base - Green Top		\$464.60	\$534.30	\$598.40	
30OSBB	30" Round Bar Table w/ Standard Black Base - Orange Top		\$464.60	\$534.30	\$598.40	
30WDBB	30" Round Bar Table w/ Standard Black Base - Barnwood Top		\$464.60	\$534.30	\$598.40	
30WH42	30" Round Bar Table w/ Standard Black Base - White Top		\$482.80	\$555.20	\$621.80	
30YBBB	30" Round Bar Table w/ Standard Black Base - Brushed Yellow Top		\$464.60	\$534.30	\$598.40	
VTB	30" Round Bar Table w/ Standard Black Base - Red Top		\$458.25	\$527.00	\$590.25	
VTJ	30" Round Bar Table w/ Standard Black Base - Graphite Nebula Top		\$458.25	\$527.00	\$590.25	
VTK	30" Round Bar Table w/ Standard Black Base - Maple Top		\$458.25	\$527.00	\$590.25	
VTA	30" Round Madison Bar Table w/ Standard Black Base - Gray Acajou Top		\$458.25	\$527.00	\$590.25	
P30BWH	30" Round Cafe Table w/ Standard Black Base - White Top  POWERED		\$938.65	\$1,079.45	\$1,209.00	

36" Round Bar Table with Black Base

CODE	ITEM	QTY	ONLINE	DISCOUNT	REGULAR	TOTAL
36BKSB	36" Round Bar Table w/ Standard Black Base - Black Top		\$458.25	\$527.00	\$590.25	
VTN	36" Round Bar Table w/ Standard Black Base - Graphite Nebula Top		\$489.90	\$563.40	\$631.00	
VTW	36" Round Bar Table w/ Standard Black Base - White Top		\$489.90	\$563.40	\$631.00	
VTP	36" Round Bar Table w/ Standard Black Base - Maple Top		\$489.90	\$563.40	\$631.00	

30" Round Bar Table with Hydraulic Base

CODE	ITEM	QTY	ONLINE	DISCOUNT	REGULAR	TOTAL
30AGHB	30" Round Bar Table w/ Hydraulic Base - Brushed Gunmetal Top		\$560.80	\$644.90	\$722.30	
30BEHB	30" Round Bar Table w/ Hydraulic Base - Blue Top		\$560.80	\$644.90	\$722.30	
30BKHB	30" Round Bar Table w/ Hydraulic Base - Black Top		\$560.80	\$644.90	\$722.30	
30BRHB	30" Round Bar Table w/ Hydraulic Base - Red Top		\$556.90	\$640.45	\$717.30	
30GRHB	30" Round Bar Table w/ Hydraulic Base - Graphite Nebula Top		\$556.90	\$640.45	\$717.30	
30GSHB	30" Round Bar Table w/ Hydraulic Base - Green Top		\$560.80	\$644.90	\$722.30	
30MTHB	30" Round Bar Table w/ Hydraulic Base - Maple Top		\$606.25	\$697.20	\$780.85	
30OSHB	30" Round Bar Table w/ Hydraulic Base - Orange Top		\$560.80	\$644.90	\$722.30	
30WDHB	30" Round Bar Table w/ Hydraulic Base - Barnwood Top		\$560.80	\$644.90	\$722.30	
30WHHB	30" Round Bar Table w/ Hydraulic Base - White Top		\$602.80	\$693.20	\$776.40	
30YSHB	30" Round Bar Table w/ Hydraulic Base - Brushed Yellow Top		\$560.80	\$644.90	\$722.30	
30MAHB	30" Round Madison Bar Table w/ Hydraulic Base - Gray Acajou Top		\$556.90	\$640.45	\$717.30	

Submission of this form indicates you read and accept the Payment Policy and Terms & Conditions. There are no exchanges or refunds once item has been delivered to your booth. Cancellations must be received in writing 14 days prior to first exhibitor move in day. Rental items found and in use in your booth are subject to "Regular" pricing.

COMPANY NAME: _____ BOOTH NUMBER: _____

CONTACT NAME: _____

EMAIL ADDRESS: _____



Email completed form to: orders@shepardes.com

BAR TABLES, BARS & COUNTERS CONTINUED

NGAUS General Conference & Exhibition

I138120824

Huntington Place | Detroit, MI

August 24 - 26, 2024

ONLINE & DISCOUNT DEADLINE:* FRIDAY, AUGUST 2, 2024

* Order with complete Method of Payment must be received before Discount Deadline date to receive discounted pricing.

36" Round Bar Table with Hydraulic Base

CODE	ITEM	QTY	ONLINE	DISCOUNT	REGULAR	TOTAL
36BKHB	36" Round Bar Table w/ Hydraulic Base - Black Top		\$560.80	\$644.90	\$722.30	
36GRHB	36" Round Bar Table w/ Hydraulic Base - Graphite Nebula Top		\$606.25	\$697.20	\$780.85	
36MTHB	36" Round Bar Table w/ Hydraulic Base - Maple Top		\$606.25	\$697.20	\$780.85	
36WTHB	36" Round Bar Table w/ Hydraulic Base - White Top		\$606.25	\$697.20	\$780.85	

Metal Bar Table

CODE	ITEM	QTY	ONLINE	DISCOUNT	REGULAR	TOTAL
RSTSQT	Rustique Square Metal Bar Table - Gunmetal		\$507.60	\$583.75	\$653.80	

Ventura Communal Bar Tables

CODE	ITEM	QTY	ONLINE	DISCOUNT	REGULAR	TOTAL
VNTBNP	Ventura Communal Bar Table - Black Top, Silver		\$1,230.20	\$1,414.75	\$1,584.50	
VNTMNP	Ventura Communal Bar Table - Maple Top, Silver		\$1,230.20	\$1,414.75	\$1,584.50	
VNTWNP	Ventura Communal Bar Table - White Top, Silver		\$1,230.20	\$1,414.75	\$1,584.50	
VNTBMW	Ventura Communal Bar Table w/ Grommet Holes - Maple Top, Silver		\$1,230.20	\$1,414.75	\$1,584.50	
VNTBWW	Ventura Communal Bar Table w/ Grommet Holes - White Top, Silver		\$1,230.20	\$1,414.75	\$1,584.50	
VNTBLK	 POWERED Ventura Communal Bar Table, Powered - Black Top, Silver		\$1,452.25	\$1,670.10	\$1,870.50	
VNTWHT	 POWERED Ventura Communal Bar Table, Powered - White Top, Silver		\$1,452.25	\$1,670.10	\$1,870.50	

 = **Electrical Power** (Client is responsible for providing labor and an electrical power source to the furniture.)

Bars

CODE	ITEM	QTY	ONLINE	DISCOUNT	REGULAR	TOTAL
MTBLPI	Midtown Bar, Lighted w/ Plug In - Taupe Glass Top, Pewter		\$2,739.60	\$3,150.55	\$3,528.60	
MTBUUL	Midtown Bar, Unlighted - Taupe Glass Top, Pewter		\$2,563.45	\$2,947.95	\$3,301.70	

Counters

CODE	ITEM	QTY	ONLINE	DISCOUNT	REGULAR	TOTAL
MTCLPI	Midtown Powered Counter, Lighted w/ Plug In - Taupe Glass Top, Pewter		\$2,739.60	\$3,150.55	\$3,528.60	
MTCFUL	Midtown Powered Counter, Unlighted - Taupe Glass Top, Pewter		\$2,579.45	\$2,966.35	\$3,322.30	

NOTE: Items may be discontinued without notice at any time.

TOTAL ESTIMATE	\$ _____
TAX (All tax rates are subject to change)	6.00%
AMOUNT DUE	\$ _____

Submission of this form indicates you read and accept the Payment Policy and Terms & Conditions. There are no exchanges or refunds once item has been delivered to your booth. Cancellations must be received in writing 14 days prior to first exhibitor move in day. Rental items found and in use in your booth are subject to "Regular" pricing.

COMPANY NAME: _____ BOOTH NUMBER: _____

CONTACT NAME: _____

EMAIL ADDRESS: _____



Email completed form to: orders@shepardes.com

shepardes.com

CAFÉ TABLES

NGAUS General Conference & Exhibition
 Huntington Place | Detroit, MI
 August 24 - 26, 2024

I138120824

ONLINE & DISCOUNT DEADLINE:* FRIDAY, AUGUST 2, 2024

* Order with complete Method of Payment must be received before Discount Deadline date to receive discounted pricing.

30" Round Café Table with Black Base

CODE	ITEM	QTY	ONLINE	DISCOUNT	REGULAR	TOTAL
30AGBC	30" Round Cafe Table w/ Standard Black Base - Brushed Gunmetal Top		\$416.60	\$479.10	\$536.60	
30BEBC	30" Round Cafe Table w/ Standard Black Base - Blue Top		\$416.60	\$479.10	\$536.60	
30BKSC	30" Round Cafe Table w/ Standard Black Base - Black Top		\$416.60	\$479.10	\$536.60	
30GSBC	30" Round Cafe Table w/ Standard Black Base - Green Top		\$416.60	\$479.10	\$536.60	
30OSBC	30" Round Cafe Table w/ Standard Black Base - Orange Top		\$416.60	\$479.10	\$536.60	
30WDDB	30" Round Cafe Table w/ Standard Black Base - Barnwood Top		\$416.60	\$479.10	\$536.60	
30WH29	30" Round Cafe Table w/ Standard Black Base - White Top		\$440.55	\$506.65	\$567.45	
30YSBC	30" Round Cafe Table w/ Standard Black Base - Brushed Yellow Top		\$416.60	\$479.10	\$536.60	
ZTA	30" Round Madison Cafe Table w/ Standard Black Base - Gray Acajou Top		\$430.00	\$494.50	\$553.85	
ZTB	30" Round Cafe Table w/ Standard Black Base - Red Top		\$415.95	\$478.35	\$535.75	
ZTJ	30" Round Cafe Table w/ Standard Black Base - Graphite Nebula Top		\$415.95	\$478.35	\$535.75	
ZTK	30" Round Cafe Table w/ Standard Black Base - Maple Top		\$415.95	\$478.35	\$535.75	
P30CWH	30" Round Cafe Table w/ Standard Black Base - White Top  POWERED		\$938.65	\$1,079.45	\$1,209.00	

36" Round Café Table with Black Base

CODE	ITEM	QTY	ONLINE	DISCOUNT	REGULAR	TOTAL
36BKSC	36" Round Cafe Table w/ Standard Black Base - Black Top		\$454.70	\$522.90	\$585.65	
ZTN	36" Round Cafe Table w/ Standard Black Base - Graphite Nebula Top		\$454.70	\$522.90	\$585.65	
ZTP	36" Round Cafe Table w/ Standard Black Base - Maple Top		\$454.70	\$522.90	\$585.65	
ZTQ	36" Round Cafe Table w/ Standard Black Base - White Top		\$454.70	\$522.90	\$585.65	

30" Round Café Table with Chrome Hydraulic Base

CODE	ITEM	QTY	ONLINE	DISCOUNT	REGULAR	TOTAL
30AGHC	30" Round Cafe Table w/ Hydraulic Base - Brushed Gunmetal Top		\$560.00	\$644.00	\$721.30	
30BEHC	30" Round Cafe Table w/ Hydraulic Base - Blue Top		\$560.80	\$644.90	\$722.30	
30BKHC	30" Round Cafe Table w/ Hydraulic Base - Black Top		\$560.00	\$644.00	\$721.30	
30BRHC	30" Round Cafe Table w/ Hydraulic Base - Red Top		\$556.90	\$640.45	\$717.30	
30GRHC	30" Round Cafe Table w/ Hydraulic Base - Graphite Nebula Top		\$606.25	\$697.20	\$780.85	
30GSHC	30" Round Cafe Table w/ Hydraulic Base - Green Top		\$560.00	\$644.00	\$721.30	
30MTHC	30" Round Cafe Table w/ Hydraulic Base - Maple Top		\$556.90	\$640.45	\$717.30	
30OSHC	30" Round Cafe Table w/ Hydraulic Base - Orange Top		\$560.00	\$644.00	\$721.30	
30WDHC	30" Round Cafe Table w/ Hydraulic Base - Barnwood Top		\$560.80	\$644.90	\$722.30	
30WHHC	30" Round Cafe Table w/ Hydraulic Base - White Top		\$602.80	\$693.20	\$776.40	
30YSHC	30" Round Cafe Table w/ Hydraulic Base - Brushed Yellow Top		\$560.00	\$644.00	\$721.30	
30MAHC	30" Round Madison Cafe Table w/ Hydraulic Base - Gray Acajou Top		\$556.90	\$640.45	\$717.30	

CAFÉ TABLES CONTINUED

NGAUS General Conference & Exhibition
 Huntington Place | Detroit, MI
 August 24 - 26, 2024

I138120824



ONLINE & DISCOUNT DEADLINE:* FRIDAY, AUGUST 2, 2024

* Order with complete Method of Payment must be received before Discount Deadline date to receive discounted pricing.

36" Round Café Table with Chrome Hydraulic Base

CODE	ITEM	QTY	ONLINE	DISCOUNT	REGULAR	TOTAL
36BKHC	36" Round Cafe Table w/ Hydraulic Base - Black Top		\$606.25	\$697.20	\$780.85	
36GRHC	36" Round Cafe Table w/ Hydraulic Base - Graphite Nebula Top		\$606.25	\$697.20	\$780.85	
36MTHC	36" Round Cafe Table w/ Hydraulic Base - Maple Top		\$606.25	\$697.20	\$780.85	
36WTHC	36" Round Cafe Table w/ Hydraulic Base - White Top		\$606.25	\$697.20	\$780.85	

Ventura Communal Café Tables

CODE	ITEM	QTY	ONLINE	DISCOUNT	REGULAR	TOTAL
VNTCBN	Ventura Communal Cafe Table - Black Top, Silver		\$945.30	\$1,087.10	\$1,217.55	
VNTCMN	Ventura Communal Cafe Table - Maple Top, Silver		\$945.30	\$1,087.10	\$1,217.55	
VNTCWN	Ventura Communal Cafe Table - White Top, Silver		\$945.30	\$1,087.10	\$1,217.55	
VNTCMW	Ventura Communal Cafe Table w/ Grommet Holes - Maple Top, Silver		\$945.30	\$1,087.10	\$1,217.55	
VNTCWW	Ventura Communal Cafe Table w/ Grommet Holes - White Top, Silver		\$945.30	\$1,087.10	\$1,217.55	
VNTCBK	Communal Ventura Cafe Table - Black Top, Silver  POWERED		\$1,073.40	\$1,234.40	\$1,382.55	
VNTCWH	Communal Ventura Cafe Table - White Top, Silver  POWERED		\$1,073.40	\$1,234.40	\$1,382.55	

 = **Electrical Power** (Client is responsible for providing labor and an electrical power source to the furniture.)
 NOTE: Items may be discontinued without notice at any time.

TOTAL ESTIMATE	\$ _____
TAX (All tax rates are subject to change)	6.00%
AMOUNT DUE	\$ _____

Submission of this form indicates you read and accept the Payment Policy and Terms & Conditions. There are no exchanges or refunds once item has been delivered to your booth. Cancellations must be received in writing 14 days prior to first exhibitor move in day. Rental items found and in use in your booth are subject to "Regular" pricing.

COMPANY NAME: _____ BOOTH NUMBER: _____

CONTACT NAME: _____

EMAIL ADDRESS: _____



Email completed form to: orders@shepardes.com

BAR STOOLS

NGAUS General Conference & Exhibition

I138120824

Huntington Place | Detroit, MI

August 24 - 26, 2024

ONLINE & DISCOUNT DEADLINE:* FRIDAY, AUGUST 2, 2024

* Order with complete Method of Payment must be received before Discount Deadline date to receive discounted pricing.

Bar Stools

CODE	ITEM	QTY	ONLINE	DISCOUNT	REGULAR	TOTAL
BSS	Banana Barstool - Black, Chrome		\$461.75	\$531.00	\$594.70	
BST	Banana Barstool - White, Chrome		\$461.75	\$531.00	\$594.70	
BLDBRD	Blade Barstool - Red		\$240.30	\$276.35	\$309.50	
BLDBSB	Blade Barstool - Sky Blue		\$240.30	\$276.35	\$309.50	
BLDBBK	Blade Barstool - Black		\$205.40	\$236.20	\$264.55	
CBSBAZ	Chelsea Barstool- Azure Blue, Black Tower Base		\$241.80	\$278.05	\$311.40	
CBSBBK	Chelsea Barstool- Black, Black Tower Base		\$241.80	\$278.05	\$311.40	
CBSBYL	Chelsea Barstool- Goldenrod Yellow, Black Tower Base		\$241.80	\$278.05	\$311.40	
CBSBGY	Chelsea Barstool- Gray, Black Tower Base		\$241.80	\$278.05	\$311.40	
CBSBOR	Chelsea Barstool- Orange, Black Tower Base		\$241.80	\$278.05	\$311.40	
CBSBWL	Chelsea Barstool- Walnut-look, Black Tower Base		\$241.80	\$278.05	\$311.40	
XBAR	Christopher Barstool - White Vinyl, Chrome		\$334.75	\$384.95	\$431.15	
LMBAR	Laguna Barstool - Maple, Chrome		\$345.35	\$397.15	\$444.80	
ROLLBL	Lift Barstool - Black Vinyl, Chrome		\$391.30	\$450.00	\$504.00	
ROLLGY	Lift Barstool - Gray Vinyl, Chrome		\$391.30	\$450.00	\$504.00	
ROLLRD	Lift Barstool - Red Vinyl, Chrome		\$391.30	\$450.00	\$504.00	
ROLLWH	Lift Barstool - White Vinyl, Chrome		\$391.30	\$450.00	\$504.00	
LUBSCL	Lucent Barstool - Frosted Acrylic, Chrome		\$480.60	\$552.70	\$619.00	
MARBBE	Marina Barstool - Ocean Blue Fabric, Brushed Metal		\$390.60	\$449.20	\$503.10	
MARBBK	Marina Barstool - Black Vinyl, Brushed Metal		\$390.60	\$449.20	\$503.10	
MARBBR	Marina Barstool - Brown Fabric, Brushed Metal		\$390.60	\$449.20	\$503.10	
MARBRD	Marina Barstool - Red Fabric, Brushed Metal		\$390.60	\$449.20	\$503.10	
MARBWH	Marina Barstool - White Vinyl, Brushed Metal		\$390.60	\$449.20	\$503.10	
RSTSTL	Rustique Barstool - Gunmetal		\$267.80	\$307.95	\$344.90	
BS001	Shark Barstool - White, Chrome		\$588.60	\$676.90	\$758.15	
BSR	Syntax Barstool - Black, Chrome		\$419.45	\$482.35	\$540.25	
ZENBAR	Zenith Barstool - White, Chrome		\$310.10	\$356.60	\$399.40	
BS002	Zoey Barstool - White, Chrome		\$539.30	\$620.20	\$694.60	

NOTE: Items may be discontinued without notice at any time.

TOTAL ESTIMATE	\$ _____
TAX (All tax rates are subject to change)	6.00%
AMOUNT DUE	\$ _____

Submission of this form indicates you read and accept the Payment Policy and Terms & Conditions. There are no exchanges or refunds once item has been delivered to your booth. Cancellations must be received in writing 14 days prior to first exhibitor move in day. Rental items found and in use in your booth are subject to "Regular" pricing.

COMPANY NAME: _____ BOOTH NUMBER: _____

CONTACT NAME: _____

EMAIL ADDRESS: _____



Email completed form to: orders@shepardes.com

shepardes.com

CONFERENCE & WORK TABLES

NGAUS General Conference & Exhibition

I138120824







Huntington Place | Detroit, MI

August 24 - 26, 2024

ONLINE & DISCOUNT DEADLINE:* FRIDAY, AUGUST 2, 2024

* Order with complete Method of Payment must be received before Discount Deadline date to receive discounted pricing.

Conference Tables

CODE	ITEM	QTY	ONLINE	DISCOUNT	REGULAR	TOTAL
BKCT5N	5' Table - Black Top, Silver		\$603.40	\$693.90	\$777.15	
BKCT5P	5' Table - Black Top, Silver  POWERED		\$781.10	\$898.25	\$1,006.05	
CONF5	5' Table - White Top, Silver		\$707.20	\$813.30	\$910.90	
C5PWR	5' Table - White Top, Silver  POWERED		\$834.60	\$959.80	\$1,075.00	
BKCT8N	8' Table - Black Top, Silver		\$1,201.25	\$1,381.45	\$1,547.20	
BKCT8P	8' Table - Black Top, Silver  POWERED		\$1,500.25	\$1,725.30	\$1,932.35	
CONF8	8' Table - White Top, Silver		\$1,341.60	\$1,542.85	\$1,728.00	
C8PWR	8' Table - White Top, Silver  POWERED		\$1,606.80	\$1,847.80	\$2,069.55	
BKCT10N	10' Table - Black Top, Silver		\$1,201.25	\$1,381.45	\$1,547.20	
BKCT10P	10' Table - Black Top, Silver  POWERED		\$1,500.25	\$1,725.30	\$1,932.35	
CONF10	10' Table - White Top, Silver		\$1,341.60	\$1,542.85	\$1,728.00	
C10PWR	10' Table - White Top, Silver  POWERED		\$1,606.80	\$1,847.80	\$2,069.55	
CB8	42" Round Madison Table - Gray Acajou, Black		\$629.40	\$723.80	\$810.65	
42BKCT	42" Round Table - Black Top, Black		\$647.15	\$744.20	\$833.50	
CONF42	42" Round Table - White Top		\$712.10	\$818.90	\$917.15	
36ATO	Atomic 36" Round Table - Glass Top, Chrome		\$588.60	\$676.90	\$758.15	
42ATO	Atomic 42" Round Table - Glass Top, Chrome		\$588.60	\$676.90	\$758.15	
CE2	Geo Table, Rectangle - Glass Top, Chrome		\$835.30	\$960.60	\$1,075.85	
CF2	Geo Table, Rectangle - Glass Top, Black		\$835.30	\$960.60	\$1,075.85	
CE1	Geo Table, Rounded Square - Glass Top, Chrome		\$588.60	\$676.90	\$758.15	
CF1	Geo Table, Rounded Square - Glass Top, Black		\$588.60	\$676.90	\$758.15	
MADC05	Madison 5' Table - Gray Acajou, Chrome		\$891.75	\$1,025.50	\$1,148.55	
MADC08	Madison 8' Table - Gray Acajou, Chrome		\$1,779.95	\$2,046.95	\$2,292.60	
MADC10	Madison 10' Table - Gray Acajou, Chrome		\$1,779.95	\$2,046.95	\$2,292.60	

Work Table

CODE	ITEM	QTY	ONLINE	DISCOUNT	REGULAR	TOTAL
WD3	Work Table - White Top, White		\$613.35	\$705.35	\$790.00	

 = **Electrical Power** (Client is responsible for providing labor and an electrical power source to the furniture.) *NOTE: Items may be discontinued without notice at any time.*

TOTAL ESTIMATE	\$ _____
TAX (All tax rates are subject to change)	6.00%
AMOUNT DUE	\$ _____

Submission of this form indicates you read and accept the Payment Policy and Terms & Conditions. There are no exchanges or refunds once item has been delivered to your booth. Cancellations must be received in writing 14 days prior to first exhibitor move in day. Rental items found and in use in your booth are subject to "Regular" pricing.

COMPANY NAME: _____ BOOTH NUMBER: _____

CONTACT NAME: _____

EMAIL ADDRESS: _____



Email completed form to: orders@shepardes.com

shepardes.com

EXECUTIVE SEATING, DESKS & STORAGE

NGAUS General Conference & Exhibition

I138120824

Huntington Place | Detroit, MI

August 24 - 26, 2024



ONLINE & DISCOUNT DEADLINE:* FRIDAY, AUGUST 2, 2024

* Order with complete Method of Payment must be received before Discount Deadline date to receive discounted pricing.

Seating

CODE	ITEM	QTY	ONLINE	DISCOUNT	REGULAR	TOTAL
CUPCHA	Cupertino Mid Back Chair - Black Vinyl		\$513.30	\$590.30	\$661.15	
GENCHA	Genesis Chair - Black		\$448.00	\$515.20	\$577.00	
PROGB	Pro Executive Guest Chair - Black Vinyl, Chrome		\$482.80	\$555.20	\$621.80	
TASKST	Task Stool - Black Fabric, Black		\$272.35	\$313.20	\$350.80	

Desks

CODE	ITEM	QTY	ONLINE	DISCOUNT	REGULAR	TOTAL
TECH	Tech Desk - Black Metal, Black Laminate w/ Electrical Unit  POWERED		\$835.30	\$960.60	\$1,075.85	
TECH3B	Tech Desk w/ 3 Drawer File Cabinet - Black Metal, Black Laminate w/ Electrical Unit  POWERED		\$1,032.80	\$1,187.70	\$1,330.20	
JD8	Madison Executive Desk - Gray Acajou, Chrome		\$1,124.45	\$1,293.10	\$1,448.25	

Storage

CODE	ITEM	QTY	ONLINE	DISCOUNT	REGULAR	TOTAL
BC8	Madison Bookcase - Gray Acajou, Chrome		\$814.15	\$936.25	\$1,048.60	
TECH3	Cabinet on Castors - Black Top, Black Metal		\$274.95	\$316.20	\$354.15	

 = **Electrical Power** (Client is responsible for providing labor and an electrical power source to the furniture.)

NOTE: Items may be discontinued without notice at any time.

TOTAL ESTIMATE	\$ _____
TAX (All tax rates are subject to change)	6.00%
AMOUNT DUE	\$ _____

Submission of this form indicates you read and accept the Payment Policy and Terms & Conditions. There are no exchanges or refunds once item has been delivered to your booth. Cancellations must be received in writing 14 days prior to first exhibitor move in day. Rental items found and in use in your booth are subject to "Regular" pricing.

COMPANY NAME: _____ BOOTH NUMBER: _____

CONTACT NAME: _____

EMAIL ADDRESS: _____



Email completed form to: orders@shepardes.com

shepardes.com

NGAUS General Conference & Exhibition
 Huntington Place | Detroit, MI
 August 24 - 26, 2024

I138120824

ONLINE & DISCOUNT DEADLINE:* FRIDAY, AUGUST 2, 2024

* Order with complete Method of Payment must be received before Discount Deadline date to receive discounted pricing.

Boxwood Hedges

CODE	ITEM	QTY	ONLINE	DISCOUNT	REGULAR	TOTAL
HDC4FT	4' Boxwood Hedge		\$817.05	\$939.60	\$1,052.35	
HDC7FT	7' Boxwood Hedge		\$1,329.85	\$1,529.35	\$1,712.85	

Stanchions

CODE	ITEM	QTY	ONLINE	DISCOUNT	REGULAR	TOTAL
STNSGN	Stanchion Sign Holder - Chrome		\$72.75	\$83.65	\$93.70	
STNCHI	Stanchion w/ Retractable Belt - Black, Chrome		\$83.45	\$95.95	\$107.45	

Dividers

CODE	ITEM	QTY	ONLINE	DISCOUNT	REGULAR	TOTAL
DIVBAR	Bar/Counter Divider - Clear, Black		\$234.35	\$269.50	\$301.85	
DIVFRE	Freestanding Divider - Clear, Silver		\$471.40	\$542.10	\$607.15	
DIVFCR	Freestanding Corner Divider - Clear, Silver		\$942.70	\$1,084.10	\$1,214.20	
DIVFWL	Freestanding Wall Divider - Clear, Silver		\$471.40	\$542.10	\$607.15	
DIVFST	Sofa/Table Divider - Clear, Silver		\$422.90	\$486.35	\$544.70	
DIVFWB	Freestanding Whiteboard Divider - White, Silver		\$587.15	\$675.20	\$756.20	
MIRWHT	Miramar Divider - White Molded Plastic		\$603.40	\$693.90	\$777.15	

NOTE: Items may be discontinued without notice at any time.

TOTAL ESTIMATE	\$ _____
TAX (All tax rates are subject to change)	6.00%
AMOUNT DUE	\$ _____

Submission of this form indicates you read and accept the Payment Policy and Terms & Conditions. There are no exchanges or refunds once item has been delivered to your booth. Cancellations must be received in writing 14 days prior to first exhibitor move in day. Rental items found and in use in your booth are subject to "Regular" pricing.

COMPANY NAME: _____ BOOTH NUMBER: _____

CONTACT NAME: _____

EMAIL ADDRESS: _____



Email completed form to: orders@shepardes.com

ACCESSORIES

NGAUS General Conference & Exhibition

I138120824

Huntington Place | Detroit, MI

August 24 - 26, 2024

ONLINE & DISCOUNT DEADLINE:* FRIDAY, AUGUST 2, 2024

* Order with complete Method of Payment must be received before Discount Deadline date to receive discounted pricing.





Charging Hub

CODE	ITEM	QTY	ONLINE	DISCOUNT	REGULAR	TOTAL
VILHUB	Village Charging Hub - Cream  POWERED		\$352.80	\$405.70	\$454.40	

Lamps

CODE	ITEM	QTY	ONLINE	DISCOUNT	REGULAR	TOTAL
LAI4	Mason Silver Table Lamp - Brushed Silver		\$267.80	\$307.95	\$344.90	
LAI5	Mason Silver Floor Lamp - Brushed Silver		\$408.85	\$470.20	\$526.60	

Pedestals

PDL36B	36" Locking Pedestal - Black  POWERED		\$934.05	\$1,074.15	\$1,203.05	
PDL36W	36" Locking Pedestal - White  POWERED		\$934.05	\$1,074.15	\$1,203.05	
PDL42B	42" Locking Pedestal - Black  POWERED		\$1,106.75	\$1,272.75	\$1,425.50	
PDL42W	42" Locking Pedestal - White  POWERED		\$1,106.75	\$1,272.75	\$1,425.50	

Shelving

PSHCSS	Posh Shelving - Chrome, Acrylic		\$955.25	\$1,098.55	\$1,230.40	
--------	---------------------------------	--	----------	------------	------------	--

 = **Electrical Power** (Client is responsible for providing labor and an electrical power source to the furniture.

NOTE: Items may be discontinued without notice at any time.

TOTAL ESTIMATE	\$ _____
TAX (All tax rates are subject to change)	6.00%
AMOUNT DUE	\$ _____

Submission of this form indicates you read and accept the Payment Policy and Terms & Conditions. There are no exchanges or refunds once item has been delivered to your booth. Cancellations must be received in writing 14 days prior to first exhibitor move in day. Rental items found and in use in your booth are subject to "Regular" pricing.

COMPANY NAME: _____ BOOTH NUMBER: _____

CONTACT NAME: _____

EMAIL ADDRESS: _____

GRAPHICS & SIGNS

NGAUS General Conference & Exhibition

I138120824

Huntington Place | Detroit, MI

August 24 - 26, 2024

DISCOUNT DEADLINE:* THURSDAY, JULY 25, 2024

* Order with complete Method of Payment must be received before Discount Deadline date to receive discounted pricing.

Sign prices are based on customer supplying print-ready graphics in the requested format. Please see our Graphic Guidelines page for specific file/artwork information and the Graphic Upload page for a step by step guide on uploading your artwork.

Foam Core Signs, Single Sided

CODE	ITEM	QTY	ONLINE	DISCOUNT	REGULAR	TOTAL
70009	22" x 28" Vertical		\$260.60	\$299.70	\$335.65	
70010	22" x 28" Horizontal		\$260.60	\$299.70	\$335.65	
70011	28" x 44" Vertical		\$396.90	\$456.45	\$511.20	
70012	28" x 44" Horizontal		\$396.90	\$456.45	\$511.20	
70027	38.25" x 90.75" Meter Board, Trovicel Panel		\$803.20	\$923.70	\$1,034.55	
70138	39" x 84" Meter Board, Ultraboard		\$466.65	\$536.65	\$601.05	

Printed Vinyl Banners (per sq. ft.)

CODE	ITEM	QTY	ONLINE	DISCOUNT	REGULAR	TOTAL
70065	Vertical with Grommets		\$33.00	\$37.95	\$42.50	
70071	Horizontal with Grommets		\$33.00	\$37.95	\$42.50	
70066	Vertical with Pockets		\$35.55	\$40.90	\$45.80	
70072	Horizontal with Pockets		\$35.55	\$40.90	\$45.80	

Table Clings

CODE	ITEM	QTY	ONLINE	DISCOUNT	REGULAR	TOTAL
70034	36" x 36" Round Table Cling <i>Table clings are made to fit our standard pedestal table tops.</i>		\$277.15	\$318.70	\$356.95	

Accessories

CODE	ITEM	QTY	ONLINE	DISCOUNT	REGULAR	TOTAL
70017	4' x 8' Blank Foamcore		\$70.70	\$81.30	\$91.05	
70021	Velcro/per ft. (Minimum of 5)		\$4.55	\$5.25	\$5.90	
70004	7" x 44" ID Sign		\$77.95	\$89.65	\$100.40	
50094	Floor Easel		\$69.90	\$80.40	\$90.05	
50095	22" x 28" Chrome Sign Holder		\$159.00	\$182.85	\$204.80	
50508	Cardboard Meter Board Base, Black		\$31.05	\$35.70	\$40.00	

TOTAL ESTIMATE	\$ _____
TAX (All tax rates are subject to change)	6.00%
AMOUNT DUE	\$ _____

Submission of this form indicates you read and accept the Payment Policy and Terms & Conditions. Due to the custom nature of this product, no refunds or cancellations are available once ordered.

COMPANY NAME: _____ BOOTH NUMBER: _____

CONTACT NAME: _____

EMAIL ADDRESS: _____



Email completed form to: orders@shepardes.com

UPLOADING GRAPHICS 101

ADDING FILES TO THE FTP.

NGAUS General Conference & Exhibition

Huntington Place | Detroit, MI

I138120824

August 24 - 26, 2024

All graphic files for ordered products should be uploaded to our FTP site. Please see Graphic Guidelines page for detailed file specifications.

Before Sending Files

1. Please name your files for easy identification using the following format:

Company Name_Booth#_Panel Letter

example: Shepard_Booth1905_Panel A.pdf

2. Packaged files should be compressed (.zip) and include document, fonts and images needed.

Submitting Your Files

1. Go to: files.shepardes.com.
2. Login to the FTP site.
User Name = sesftp
Password = ftpftp
3. Click the [Go to Files](#) button.
4. Select the "Drop Off" folder.
5. Navigate to the show folder using the following path:
Year → Month → Show Name → Exhibitor Uploads
example: 2020 → 01_Shepard Show → Exhibitor Uploads
6. Upload files by drag and drop OR by selecting the [Upload](#) button and browse to the files you want to upload.
NOTE: You can create additional folders using the New Folder button to help with organizing uploads. Be careful when doing this, as you can not delete these.
7. When upload is complete, email the name of your files to:
orders@shepardes.com with the subject line: "Show Name" FTP Upload.

Failure to follow these steps could result in delayed graphics.

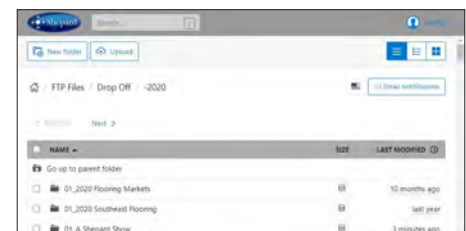

SHEPARD GRAPHIC GUIDELINES

DIRECT TO SUBSTRATE PRINTING.

Ensure your brand is professionally showcased.
With Shepard, You Can.





Our talented, in-house design team provides graphic layout services to ensure a seamless transfer of files for print and production. If files are being provided, please provide these guidelines to your designer to use as a roadmap for designing and submitting graphics.

Document Size & Specs

- All artwork should be created at 100% size at 150 dpi or in a proportionally scaled down format.
examples: 50% at 300 dpi OR 25% at 600 dpi
- Please mark artwork size if scaled down.
example: DESIGNED AT 50%
- All content should be kept within the live area, leave approximately 2" all the way around artwork to ensure sign holder or structure metal does not cut off content.
- When working between Adobe programs, DO NOT copy & paste objects from Illustrator to InDesign files. This causes objects to not print correctly. Save elements from Illustrator and place them in InDesign.

Acceptable File Formats

Shepard uses the most current version of Adobe Creative Cloud®. If providing native files from another version, please also provide an .idml file. **WE DO NOT ACCEPT:** Microsoft® Word®, Excel®, or PowerPoint® files.

PROGRAM	FILE EXTENSION	SPECIAL CONSIDERATIONS
 Acrobat	.pdf	Must be high resolution with fonts embedded.
 InDesign	.indd or .idml	Images embedded and fonts changed to outlines or send a packaged file with fonts and images.
 Illustrator	.ai or .eps	Vector artwork. Images embedded and fonts changed to outlines or send a packaged file with fonts and images.
 Photoshop	.psd .tiff .jpeg .eps	Raster artwork. Must be built in CMYK color space.

Color

- Artwork must be created in the **CMYK color space**.
- If **PMS color matching** is required during the printing process, please **use Pantone®+ Solid Coated swatches** in your artwork.
- Converting color from RGB to CMYK will change the vibrancy and the look of some effects, DO NOT design artwork in RGB. Colors may vary due to output devices.



RGB Color Space.



CMYK Color Space.

Fonts & Links

If creating artwork in Adobe® InDesign® or Illustrator® there are two options when supplying fonts.

- **Change fonts to outlines.** This prevents fonts defaulting or being substituted throughout the layout and production process. *REMEMBER: if creating outlines, text is no longer editable.*
- **Package the fonts.** From InDesign or Illustrator select File → Package → Check “Copy Fonts” and submit PC format TTF fonts or OTF fonts with your artwork.
- **Package the links.** From InDesign or Illustrator select File → Package → Check “Copy Linked Graphics” and submit all images with your artwork.

SHEPARD GRAPHIC GUIDELINES

CONTINUED

Artwork can be created in several ways. Here are some things to consider.

Vector

- Vector-based artwork is resolution independent and can be enlarged or reduced without loss of quality.
- This is the preferred file type and is most often created in Illustrator and used for creation of logos and icons.

Raster

- Raster-based artwork is resolution dependent and will reproduce poorly if the appropriate file resolution is not supplied correctly.
- If supplying raster art, it is best to save your artwork in a 1 to 1 (full size) output ratio at 150 dpi or higher. Lower resolutions (1MB or smaller) will result in reduced image quality. File size should not exceed 200MB (if possible).
- Raster images are most often created in Photoshop and is most often used for photographic images.



Vector Logo at 100% scale.



Vector Logo at 200% scale.



Raster Logo at 100% scale.



Raster Logo at 200% scale.

Resolution

- Artwork should scale to 150 dpi at 100% scale to ensure the artwork remains high resolution when printed at full size. See examples and samples below.

*examples: 1:1 or 100% - resolution no less than 150 dpi
2:1 or 50% - resolution no less than 300 dpi
4:1 or 25% - resolution no less than 600 dpi*

- Images pulled from the Internet are NOT suitable for high quality, large format printing. These images are low resolution and will not reproduce well.
- Verify resolution by viewing artwork on the screen at full size in high definition. Observe image from different distances away, artwork is typically view from a couple feet away.

Before Sending Files

- Please name your files appropriately for easy identification.

*examples: Poster_22x28.pdf
Panel A_1920x898_Qty3.pdf
Shepard_Booth1905_Panel A.pdf*

- Clients should compress information that they transfer electronically (.zip).

NOTE: Please provide a JPEG thumbnail or low resolution PDF of the graphic for the Account Executive to view, this helps when creating/entering orders in our system.

Submitting Your Files

- **FTP.** Ask your Account Executive to create a folder in the "Dropoff Folder." Packaged files should be compressed (.zip).

Website: files.shepardes.com

Login: **sesftp**

Password: **ftpftp**

- **Email Attachment.** MAXIMUM SIZE: 10MB
- **Large File Transfer Site.** DropBox, YouSendIt, WeTransfer, Hightail, etc.

ELEVATE YOUR EXHIBIT

With Shepard, You Can.

What are *your* exhibit goals?

Whether you're new to the exhibits space or a seasoned pro, Shepard's here to help. We're your go-to exhibits partner.

- Bring your brand to life
- Attract attention
- Generate traffic
- Create an engaging experience
- Make exhibiting easy



High-impact Exhibits

Whatever your needs (or budget), Shepard's got you covered.

- **Custom Fabrication** for a signature look & feel
- **Custom Rental** for ultimate flexibility
- **Fabric Panels** for maximum ease



Offering innovative exhibit frameworks...and more!

- Graphic design & printing
- Equipment & furnishings
- Audio visual
- Logistics



Why Shepard?

- **Complimentary consultation:**
We listen, we strategize—and propose on-target ideas
- **Blue Diamond customer service:**
Fast, courteous, thoughtful—Shepard's there for you
- **Smart, strategic solutions:**
Shepard delivers exhibits that engage your audiences

SHIELDS & BARRIERS

NGAUS General Conference & Exhibition

I138120824

Huntington Place | Detroit, MI

August 24 - 26, 2024

ONLINE & DISCOUNT DEADLINE:* THURSDAY, JULY 25, 2024

* Order with complete Method of Payment must be received before Discount Deadline date to receive discounted pricing. Counters and Furnishings not included.

Plexi Shields



Counters not included.

CODE	ITEM	QTY	ONLINE	DISCOUNT	REGULAR	TOTAL
66651	Standard Plexi Shield (CVPS1) 40" (l) x 36" (h)		\$481.45	\$553.65	\$620.10	
66652	Tall Plexi Shield (CVPS2) 40" (l) x 44" (h)		\$592.55	\$681.45	\$763.20	
66653	Curved Plexi Shield (CVPS3) 4' 8.75" (l) x 4' (h) x 2' 2.25" (d)		\$740.70	\$851.80	\$954.00	

Walls & Dividers

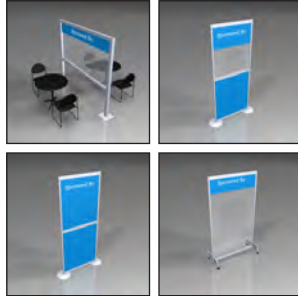

CODE	ITEM	QTY	ONLINE	DISCOUNT	REGULAR	TOTAL
66654	Large Wall Divider (CVDW1) 9' 1.25" (l) x 7' (h) x 11.85" (d) base 30" from floor		\$740.70	\$851.80	\$954.00	
66655	Plexi/Trovicel Panel Wall Divider (CVDW2) 3' 4.5" (l) x 8' high x Approx. 6" (d) base		\$518.50	\$596.25	\$667.80	
66656	Trovicel/Trovicel Wall Divider (CVDW3) 3' 4.5" (l) x 8' (h) x 1' 9" (d) base		\$444.40	\$511.05	\$572.40	
66657	Plexi Rolling Baffle (CVDW4) 4' 2.5" (l) x 7' (h) x 1' 9" (d) base		\$925.85	\$1,064.75	\$1,192.50	

Sanitizer Kiosk



CODE	ITEM	QTY	ONLINE	DISCOUNT	REGULAR	TOTAL
66650	Sanitizer Kiosk A (CVSKI) 40" (l) x 36" (h)		\$555.55	\$638.90	\$715.55	

TOTAL ESTIMATE	\$ _____
TAX (All tax rates are subject to change)	6.00%
AMOUNT DUE	\$ _____

Submission of this form indicates you read and accept the Payment Policy and Terms & Conditions. There are no exchanges or refunds once item has been delivered to your booth. Cancellations must be received in writing 30 days prior to first exhibitor move in day. Rental items found and in use in your booth are subject to "Regular" pricing.

COMPANY NAME: _____ BOOTH NUMBER: _____

CONTACT NAME: _____

EMAIL ADDRESS: _____

EXHIBIT COUNTER RENTALS

NGAUS General Conference & Exhibition

I138120824

Huntington Place | Detroit, MI

August 24 - 26, 2024

ONLINE & DISCOUNT DEADLINE:* THURSDAY, JULY 25, 2024

* Order with complete Method of Payment must be received before Discount Deadline date to receive discounted pricing. Additional Rush charges may be applied to orders placed after deadline or on-site.

Choose Your Counter & Customize to Fit Your Exhibit!

AVAILABLE COLORS FOR ALL PRODUCTS:

Metal Colors: Silver (15) and **Panel Colors:** White (03) or Black (06)

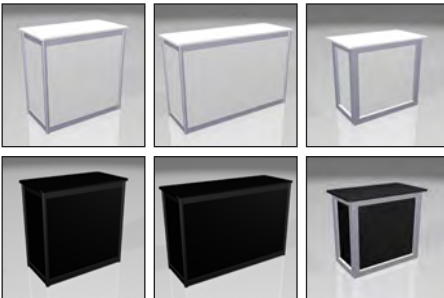

Locking Cabinets

CODE	ITEM	QTY	ONLINE	DISCOUNT	REGULAR	PANEL COLOR
6628203 (w) 6628206 (b)	1 Meter Locking Cabinet (LC1) 3' 6" (l) x 3' 6" (h) x 1' 9" (d) <i>Graphic Size: 968mm x 898mm</i>		\$1,218.25	\$1,401.00	\$1,569.10	
6628303 (w) 6628306 (b)	1.5 Meter Locking Cabinet (LC2) 5' (l) x 3' 6" (h) x 1' 9" (d) <i>Graphic Size: 1463mm x 898mm</i>		\$1,478.30	\$1,700.05	\$1,904.05	
6628403(w) 6628406 (b)	Locking Cabinet (LC3) 3' 9" (l) x 3' 6" (h) x 2' 3" (d) <i>Graphic Size: 922mm x 872mm</i>		\$898.65	\$1,033.45	\$1,157.45	

Reception Counters

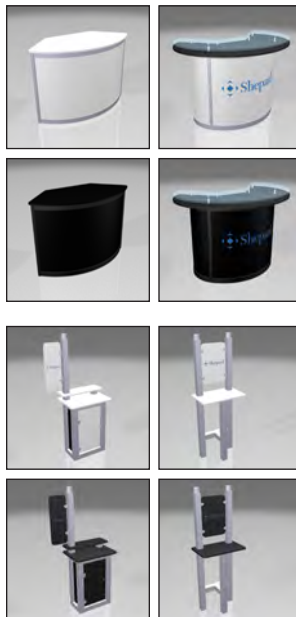

CODE	ITEM	QTY	ONLINE	DISCOUNT	REGULAR	PANEL COLOR
6627503 (w) 6627506 (b)	Reception Counter (RC2) 4'10.75" (l) x 40" (h) x 2' 4.75" (d) <i>Graphic Size: 1530mm x 898mm</i>		\$1,252.75	\$1,440.65	\$1,613.55	
6627603 (w) 6627606 (b)	Reception Counter (RC3) 5' 2.75" (l) x 42" (h) x 3' 5.5" (d) <i>Graphic Size: 1080mm x 898mm</i>		\$2,717.60	\$3,125.25	\$3,500.30	

Computer Stands - Silver Metal Only (graphic included!)

CODE	ITEM	QTY	ONLINE	DISCOUNT	REGULAR	PANEL COLOR
6628503 (w) 6628506 (b)	Computer Stand 1 (CS1) 3' (l) x 6' 3" (h) x 1' 9" (d) <i>Graphic Size: 250mm x 700mm</i>		\$1,580.40	\$1,817.45	\$2,035.55	
6628603 (w) 6628606 (b)	Computer Stand 2 (CS2) 2' 3" (l) x 6' 3" (h) x 1' 6" (d) <i>Graphic Size: 380mm x 580mm</i>		\$921.20	\$1,059.40	\$1,186.55	

TOTAL ESTIMATE	\$ _____
TAX (<i>All tax rates are subject to change</i>)	6.00%
AMOUNT DUE	\$ _____

Submission of this form indicates you read and accept the Payment Policy and Terms & Conditions. All orders canceled by the exhibitor within 30 days of first day of exhibitor move in day may be subject to cancellation fees up to 100% of the total order, based upon the status of move-in, work performed and/or Shepard set-up costs or expenses.

COMPANY NAME: _____ BOOTH NUMBER: _____

CONTACT NAME: _____

EMAIL ADDRESS: _____



Email completed form to: exhibits@shepardes.com

PRODUCT DISPLAYS & CHARGING STATION RENTALS

NGAUS General Conference & Exhibition

I138120824

Huntington Place | Detroit, MI

August 24 - 26, 2024

ONLINE & DISCOUNT DEADLINE:* THURSDAY, JULY 25, 2024

* Order with complete Method of Payment must be received before Discount Deadline date to receive discounted pricing. Additional Rush charges may be applied to orders placed after deadline or on-site.

Choose Your Unit & Customize to Fit Your Products!

AVAILABLE COLORS FOR ALL PRODUCTS:

Metal Colors: Black (06) or Silver (15) and **Panel Colors:** White (03) or Black (06)

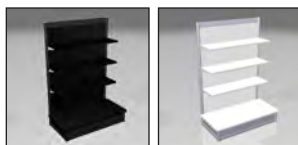

Product Displays

CODE	ITEM	QTY	ONLINE	DISCOUNT	REGULAR	PANEL COLOR
6627703 (w) 6627706 (b)	Gondola 3' 6" (l) x 4' 6" (h) x 1'3" (d)		\$853.70	\$981.75	\$1,099.55	
6627803 (w) 6627806 (b)	GL1 5' 4" (l) x 8' (h) x 1' 3" (d) <i>Graphic Sizes: 674mm x 1682mm</i>		\$843.90	\$970.50	\$1,086.95	
6627903 (w) 6627906 (b)	GL2 4' 3" (l) x 7' (h) x 1' 3" (d) <i>Graphic Sizes: 674mm x 1682mm</i>		\$1,454.65	\$1,672.85	\$1,873.60	

Showcases

CODE	ITEM	QTY	ONLINE	DISCOUNT	REGULAR	PANEL COLOR
6627003 (w) 6627006 (b)	Quarterview Showcase (Qtrview) 4' 6" (l) x 3' 3" (h) x 1'9" (d)		\$1,643.60	\$1,890.15	\$2,116.95	
6627203 (w) 6627206 (b)	Square Showcase (Square) 1'9" (l) x 7' (h) x 1'9" (d)		\$1,773.90	\$2,040.00	\$2,284.80	

Charging Unit

CODE	ITEM	QTY	ONLINE	DISCOUNT	REGULAR	PANEL COLOR
66430	Phone Charging Station (PCS) 3' (l) x 6' 3" (h) x 1'9" (d) <i>Graphic Size: 380mm x 710mm</i>		\$2,792.40	\$3,211.25	\$3,596.60	Black ONLY

Perforated/Peg Boards

CODE	ITEM	QTY	ONLINE	DISCOUNT	REGULAR
66148	8' x 4' Pegboard Panel (PerfH)		\$415.05	\$477.30	\$534.60
66149	4' x 8' Pegboard Panel (PerfV)		\$415.05	\$477.30	\$534.60
50104	6" Pegs - 1 dozen (6"Pegs)		\$67.80	\$77.95	\$87.30
66147	3.5' x 8' Slat Wall, Grey (Slatwall)		\$415.05	\$477.30	\$534.60

TOTAL ESTIMATE	\$ _____
TAX (<i>All tax rates are subject to change</i>)	6.00%
AMOUNT DUE	\$ _____

Submission of this form indicates you read and accept the Payment Policy and Terms & Conditions. All orders canceled by the exhibitor within 30 days of first day of exhibitor move in day may be subject to cancellation fees up to 100% of the total order, based upon the status of move-in, work performed and/or Shepard set-up costs or expenses.

COMPANY NAME: _____ BOOTH NUMBER: _____

CONTACT NAME: _____

EMAIL ADDRESS: _____



Email completed form to: exhibits@shepardes.com

INLINE BOOTH RENTALS

NGAUS General Conference & Exhibition

I138120824

Huntington Place | Detroit, MI

August 24 - 26, 2024

ONLINE & DISCOUNT DEADLINE:* THURSDAY, JULY 25, 2024

* Order with complete Method of Payment must be received before Discount Deadline date to receive discounted pricing. Additional Rush charges may be applied to orders placed after deadline or on-site.

Turnkey Rental Designs Make Exhibiting Easier!

Carpet and Electricity not included. Please order as needed. All Exhibit Booth Rentals include installation/dismantling and graphic panels as shown for print-ready graphics. If graphics submitted are not print-ready, additional fees may apply. Monitor and lighting options available.

Don't see what you are looking for or need a tweak to a design? Let one of our incredible designers create a space just for you! Please contact an Exhibit Team member with any questions or customization requests.



The Eddie



The Jonathon



The Pierce



The Madison



The Grant



The Harrison

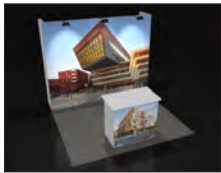

The Hamilton



The Lucy

Inline Booths

CODE	ITEM	QTY	ONLINE	DISCOUNT	REGULAR	TOTAL
66470	The Eddie - 10' x 10'		\$4,955.15	\$5,698.40	\$6,382.20	
66471	The Eddie - 10' x 20'		\$8,069.05	\$9,279.40	\$10,392.95	

CODE	ITEM	QTY	ONLINE	DISCOUNT	REGULAR	TOTAL
66474	The Jonathon - 10' x 10'		\$3,456.85	\$3,975.40	\$4,452.45	
66475	The Jonathon - 10' x 20'		\$6,050.85	\$6,958.50	\$7,793.50	

CODE	ITEM	QTY	ONLINE	DISCOUNT	REGULAR	TOTAL
66477	The Pierce - 10' x 10'		\$4,287.80	\$4,930.95	\$5,522.65	
66478	The Pierce - 10' x 20'		\$8,141.30	\$9,362.50	\$10,486.00	

CODE	ITEM	QTY	ONLINE	DISCOUNT	REGULAR	TOTAL
66484	The Madison - 10' x 10'		\$5,199.70	\$5,979.65	\$6,697.20	
66485	The Madison - 10' x 20'		\$6,162.50	\$7,086.85	\$7,937.25	

CODE	ITEM	QTY	ONLINE	DISCOUNT	REGULAR	TOTAL
66486	The Grant - 10' x 10'		\$5,488.40	\$6,311.65	\$7,069.05	
66487	The Grant - 10' x 20'		\$7,606.90	\$8,747.95	\$9,797.70	

CODE	ITEM	QTY	ONLINE	DISCOUNT	REGULAR	TOTAL
66492	The Harrison - 10' x 10'		\$5,045.65	\$5,802.50	\$6,498.80	
66493	The Harrison - 10' x 20'		\$7,414.25	\$8,526.40	\$9,549.55	

CODE	ITEM	QTY	ONLINE	DISCOUNT	REGULAR	TOTAL
66467	The Hamilton - 10' x 10'		\$3,515.90	\$4,043.30	\$4,528.50	
66468	The Hamilton - 10' x 20'		\$6,159.55	\$7,083.50	\$7,933.50	

CODE	ITEM	QTY	ONLINE	DISCOUNT	REGULAR	TOTAL
66473	The Lucy - 10' x 10'		\$3,177.60	\$3,654.25	\$4,092.75	

TOTAL ESTIMATE	\$ _____
TAX (All tax rates are subject to change)	6.00%
AMOUNT DUE	\$ _____

Submission of this form indicates you read and accept the Payment Policy and Terms & Conditions. All orders canceled by the exhibitor within 30 days of first day of exhibitor move in day may be subject to cancellation fees up to 100% of the total order, based upon the status of move-in, work performed and/or Shepard set-up costs or expenses.

COMPANY NAME: _____ BOOTH NUMBER: _____

CONTACT NAME: _____

EMAIL ADDRESS: _____



Email completed form to: exhibits@shepardes.com

FABEX BOOTH RENTALS

NGAUS General Conference & Exhibition

I138120824

Huntington Place | Detroit, MI

August 24 - 26, 2024

ONLINE & DISCOUNT DEADLINE:* THURSDAY, JULY 25, 2024

* Order with complete Method of Payment must be received before Discount Deadline date to receive discounted pricing. Additional Rush charges may be applied to orders placed after deadline or on-site.

Carpet is not included. Please use the Flooring Order Form to order carpet or other flooring options.

All Exhibit Booth Rentals include installation/dismantling and graphic panels as shown for print-ready graphics. If graphics submitted are not print-ready, additional fees may apply. Monitor and lighting options available.

Please contact an Exhibit Team member with any questions.



FX21



FX2H1



FX22



FX2H2

10' x 10' Fabric Booth

CODE	ITEM	QTY	ONLINE	DISCOUNT	REGULAR	TOTAL
66557	10' x 10' Booth (FX21)		\$3,267.40	\$3,757.50	\$4,208.40	
66561	10' x 10' Booth with Header (FX2H1)		\$3,998.00	\$4,597.70	\$5,149.40	

GRAPHIC SIZE SPECIFICATIONS

Backwall Graphic Size	3042mm x 2432mm	Side Panel Colors	<input type="checkbox"/> White <input type="checkbox"/> Black
Counter Graphic Size	1079mm x 1020mm		
Header Graphic Size	2440mm x 380mm		

10' x 20' Fabric Booth

CODE	ITEM	QTY	ONLINE	DISCOUNT	REGULAR	TOTAL
66559	10' x 20' Booth (FX22)		\$5,663.50	\$6,513.00	\$7,294.55	
66567	10' x 20' Booth with Header (FX2H2)		\$6,317.10	\$7,264.65	\$8,136.40	

GRAPHIC SIZE SPECIFICATIONS

Backwall Graphic Size	6012mm x 2432mm	Side Panel Colors	<input type="checkbox"/> White <input type="checkbox"/> Black
Counter Graphic Size	1079mm x 1020mm		
Header Graphic Size	2440mm x 380mm		

TOTAL ESTIMATE	\$ _____
TAX (All tax rates are subject to change)	6.00%
AMOUNT DUE	\$ _____

Submission of this form indicates you read and accept the Payment Policy and Terms & Conditions. All orders canceled by the exhibitor within 30 days of first day of exhibitor move in day may be subject to cancellation fees up to 100% of the total order, based upon the status of move-in, work performed and/or Shepard set-up costs or expenses.

COMPANY NAME: _____ BOOTH NUMBER: _____

CONTACT NAME: _____

EMAIL ADDRESS: _____



Email completed form to: exhibits@shepardes.com

FABEX BACKLIT BOOTH RENTALS

NGAUS General Conference & Exhibition

I138120824

Huntington Place | Detroit, MI

August 24 - 26, 2024

ONLINE & DISCOUNT DEADLINE:* THURSDAY, JULY 25, 2024

* Order with complete Method of Payment must be received before Discount Deadline date to receive discounted pricing. Additional Rush charges may be applied to orders placed after deadline or on-site.

Freestanding 8' High Backlit Backwalls with Full Color Graphics

Carpet/flooring, furnishings, electrical and accessories not included. Please use the appropriate order forms to order these items.

All Exhibit Booth Rentals include installation/dismantling and graphic panels as shown for print-ready graphics. If graphics submitted are not print-ready, additional fees may apply. Monitor and lighting options available.

Please contact an Exhibit Team member with any questions.

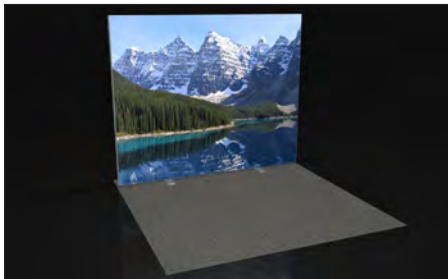

FX11

Freestanding 8' High Backlit Backwalls with Full Color Graphics

CODE	ITEM	QTY	ONLINE	DISCOUNT	REGULAR	TOTAL
66564	8' x 10' Backlit Backwall with Graphics (FX11) <i>Graphic Size: 2992mm x 2436mm</i>		\$3,294.70	\$3,788.90	\$4,243.55	
66565	8' x 20' Backlit Backwall with Graphics (FX12) <i>Graphic Size: 5992mm x 2436mm</i>		\$5,091.70	\$5,855.45	\$6,558.10	
66566	8' x 30' Backlit Backwall with Graphics (FX13) <i>Graphic Size: 8992mm x 2436mm</i>		\$6,888.75	\$7,922.05	\$8,872.70	

TOTAL ESTIMATE	\$ _____
TAX (All tax rates are subject to change)	6.00%
AMOUNT DUE	\$ _____



FX12

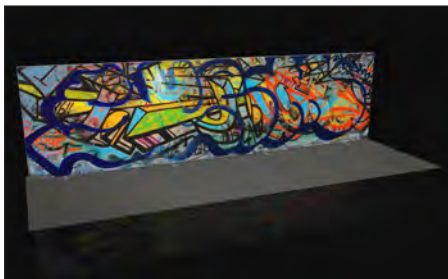

FX13

Submission of this form indicates you read and accept the Payment Policy and Terms & Conditions. All orders canceled by the exhibitor within 30 days of first day of exhibitor move in day may be subject to cancellation fees up to 100% of the total order, based upon the status of move-in, work performed and/or Shepard set-up costs or expenses.

COMPANY NAME: _____ BOOTH NUMBER: _____

CONTACT NAME: _____

EMAIL ADDRESS: _____



Email completed form to: exhibits@shepardes.com

ISLAND BOOTH RENTALS

NGAUS General Conference & Exhibition

I138120824

Huntington Place | Detroit, MI

August 24 - 26, 2024

ONLINE & DISCOUNT DEADLINE:* THURSDAY, JULY 25, 2024

* Order with complete Method of Payment must be received before Discount Deadline date to receive discounted pricing. Additional Rush charges may be applied to orders placed after deadline or on-site.

Turnkey Rental Designs Make Exhibiting Easier!

Carpet and electricity not included. Please order as needed. All Exhibit Booth Rentals include installation/dismantling and graphic panels as shown for print-ready graphics. If graphics submitted are not print-ready, additional fees may apply. Monitor and lighting options available.

Please contact an Exhibit Team member with any questions.



The Monroe

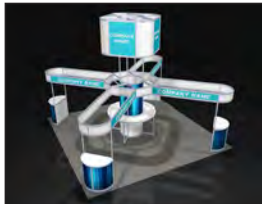

The Washington

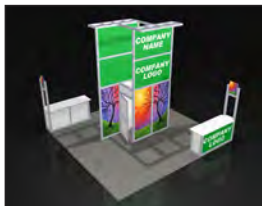

The Tyler



The Garfield

Island Booths

CODE	ITEM	QTY	ONLINE	DISCOUNT	REGULAR	TOTAL
66494	The Monroe		\$12,613.85	\$14,505.95	\$16,246.65	
66368	The Washington		\$18,102.45	\$20,817.80	\$23,315.95	
66495	The Tyler		\$13,470.95	\$15,491.60	\$17,350.60	
66496	The Garfield		\$13,191.55	\$15,170.30	\$16,990.75	

TOTAL ESTIMATE	\$ _____
TAX (All tax rates are subject to change)	6.00%
AMOUNT DUE	\$ _____

Submission of this form indicates you read and accept the Payment Policy and Terms & Conditions. All orders canceled by the exhibitor within 30 days of first day of exhibitor move in day may be subject to cancellation fees up to 100% of the total order, based upon the status of move-in, work performed and/or Shepard set-up costs or expenses.

COMPANY NAME: _____ BOOTH NUMBER: _____

CONTACT NAME: _____

EMAIL ADDRESS: _____



Email completed form to: exhibits@shepardes.com

FABRIC HANGING SIGNS

NGAUS General Conference & Exhibition

I138120824

Huntington Place | Detroit, MI

August 24 - 26, 2024

ONLINE & DISCOUNT DEADLINE:* THURSDAY, JULY 25, 2024

* Order with complete Method of Payment must be received before Discount Deadline date to receive discounted pricing. Additional Rush charges may be applied to orders placed after deadline or on-site.

Full Color Fabric Signs - High Visibility, Cost Effective Rental!

All rentals include:**

- Dye Sublimation Printed Fabric Pillow Case
- Basic Harness
- Weighs Under 75 Pounds
- Rental Frame
- Blockout Liner

** Rigging not included



Circle

Circle Hanging Signs

CODE	ITEM	QTY	ONLINE	DISCOUNT	REGULAR	TOTAL
69140	10' x 48" Circle Hanging Sign (HSC10)		\$7,943.90	\$9,135.50	\$10,231.75	
69142	16' x 48" Circle Hanging Sign (HSC16)		\$12,625.55	\$14,519.40	\$16,261.75	

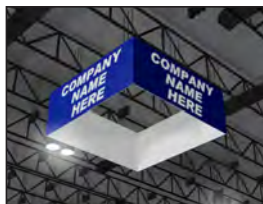

Square

Square Hanging Sign

CODE	ITEM	QTY	ONLINE	DISCOUNT	REGULAR	TOTAL
69143	10' x 48" Square Hanging Sign (HSS10)		\$9,659.80	\$11,108.75	\$12,441.80	

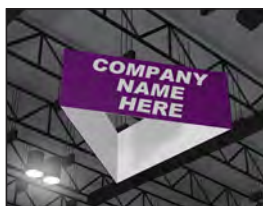

Triangle

Triangle Hanging Sign

CODE	ITEM	QTY	ONLINE	DISCOUNT	REGULAR	TOTAL
69144	10' x 48" Triangle Hanging Sign (HST10)		\$7,816.70	\$8,989.20	\$10,067.90	

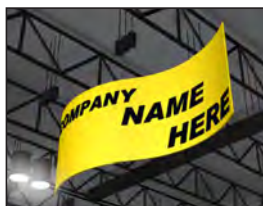

Wave

Wave Hanging Signs

CODE	ITEM	QTY	ONLINE	DISCOUNT	REGULAR	TOTAL
69145	10' x 48" Single Sided Wave Hanging Sign (HSWS)		\$3,442.40	\$3,958.75	\$4,433.80	
69146	10' x 48" Double Sided Wave Hanging Sign (HSWD)		\$4,580.75	\$5,267.85	\$5,900.00	

TOTAL ESTIMATE	\$ _____
TAX (All tax rates are subject to change)	6.00%
AMOUNT DUE	\$ _____

Submission of this form indicates you read and accept the Payment Policy and Terms & Conditions. All orders canceled by the exhibitor within 30 days of first day of exhibitor move in day may be subject to cancellation fees up to 100% of the total order, based upon the status of move-in, work performed and/or Shepard set-up costs or expenses.

COMPANY NAME: _____ BOOTH NUMBER: _____

CONTACT NAME: _____

EMAIL ADDRESS: _____



Email completed form to: exhibits@shepardes.com

ADVANCED SHIPPING HANGING SIGN LABEL

NGAUS General Conference & Exhibition

I138120824

Huntington Place | Detroit, MI

August 24 - 26, 2024

Print at least one advanced shipping label for each box. Include the exhibiting company name and booth number. If you are creating your own labels, make sure the same information below is on your labels.

If you have a sign or anything (truss, etc.) that has been approved to hang from the ceiling, send it to the advance shipping warehouse address. Hanging items must be identified and readily available since they are installed first, before the show floor becomes encumbered by freight.

ADVANCED WAREHOUSE	 ADVANCED WAREHOUSE HANGING SIGN
	TO: <hr/> <p>(Exhibiting Company Name)</p> <hr/> <p>(Exhibiting Company Booth Number)</p> <p>SES c/o T Force c/o JW Cole and Sons 6500 Mt Elliott Ave Detroit, MI 48211</p> <p>FOR: NGAUS General Conference & Exhibition</p> <hr/> <p>Delivery Hours: Monday - Friday, 8:00AM - 4:00PM First day freight can arrive without a surcharge: Thursday, July 25, 2024 Last day freight can arrive without a surcharge: Wednesday, August 14, 2024</p>

HANGING SIGNS 101

THINGS TO KNOW.

All signs must be designed to comply with Show Organizer rules and regulations and facility limitations. Shepard is responsible for assembly, installation, and removal of all hanging signs, overhead truss, attachment and removal of light fixtures for truss and lights, as well as any additional installation required for chain motors, span sets or other packages.

Only Shepard personnel are allowed in aerial lifts or operate mechanical equipment.

Only Shepard certified riggers can install and remove any and all hanging materials that will be flown overhead.

All signs, with the exception of banners, must have structural rigging points and signs exceeding 200 pounds must include detailed construction plans with a current structural engineer's stamp. Send these plans to Customer Service in advance of the first day of move in.

Signs weighing over 200 pounds may require a motor and other additional charges.

Include engineer-stamped drawings with hanging instructions as well as a set of assembly instructions (placement/orientation/height from floor) with the order. Shepard accepts no liability for any work completed without such instructions, when required.

If your sign requires electricity, make sure it is in working order and in accordance with the National Electric Code.

Overhead Signs should be sent in a separate container directly to the advance warehouse using the Advance Hanging Sign Shipping Label.

Each facility is different and additional charges may be applied by Shepard due to regulations at the facility, weight limits, union jurisdictions, facility contracts, and in house providers. Including but not limited to: spanner truss for load points, additional labor for power and/or lighting specifics, additional materials, facility pick point ceiling fees, facility and/or in house exclusive labor charges, etc.

If you require a reflective ceiling plot (RCP). We can design one for you for an additional design fee.

Hanging Sign Checklist

- Submit Method of Payment Online
- Order Assembly labor to have your sign built by Shepard Certified Riggers
- Order Rigging Install and Removal labor for all Hanging Signs, Truss and Motors
- Order necessary Chain Motors, Rotating Motors and Truss
- Place electrical orders (if necessary)
- Submit Diagrams with orientation, dimensions and placement for ALL materials that will be flown overhead
- Package Hanging Sign(s) in a separate container from exhibit materials
- Label Hanging Sign(s) using the Hanging Sign Shipping Label from this service manual
- Ship Hanging Sign(s) to the Advance Warehouse by: **Wednesday, August 14, 2024**

ORDERS PLACED AND DIAGRAMS SUBMITTED WITHIN 30 DAYS OF MOVE IN ARE SUBJECT TO ADDITIONAL LATE FEES.

STRUCTURAL INTEGRITY STATEMENT

NGAUS General Conference & Exhibition

I138120824

Huntington Place | Detroit, MI

August 24 - 26, 2024

ONLINE & DISCOUNT DEADLINE:* FRIDAY, AUGUST 2, 2024

* Order with complete Method of Payment must be received before Discount Deadline date to receive discounted pricing. Additional Rush charges may be applied to orders placed after deadline or on-site.

This form must be completed for all suspended structures. Please include the completed form with your hanging sign order forms.

As the contracted exhibitor, the display house or builder for the below exhibitor, I do hereby certify and guarantee that the stress points for the hanging structure have been properly engineered and tested. We further certify that the structure can be hung safely and has been constructed to meet all applicable regulations and safety measures. We hereby release, indemnify and forever hold harmless the following:

**Huntington Place
1 Washington Boulevard
Detroit, MI 48226**

SHEPARD EXPOSITION SERVICES

along with their subsidiaries, their directors, officers, employees, representatives, agents and contractors from and against any and all liability, claims, damage, loss, fines, or penalties arising from the installation, use or dismantling of this structure. All hang points supporting in excess of 200 lbs. may be verified (metered) on-site at the exhibitor's expense.

EXHIBITING COMPANY NAME: _____ BOOTH NUMBER: _____

EMAIL ADDRESS: _____

AUTHORIZED NAME (printed): _____

AUTHORIZED SIGNATURE: _____ DATE: _____

DISPLAY HOUSE/BUILDER (if applicable): _____

EMAIL ADDRESS: _____

AUTHORIZED NAME (printed): _____

AUTHORIZED SIGNATURE: _____ DATE: _____



Email completed form to: overheadrigging@shepardes.com

shepardes.com

HANG SIGN ASSEMBLY/DISASSEMBLY

NGAUS General Conference & Exhibition

I138120824

Huntington Place | Detroit, MI

August 24 - 26, 2024

ONLINE & DISCOUNT DEADLINE:* FRIDAY, AUGUST 2, 2024

* Order with complete Method of Payment must be received before Discount Deadline date to receive discounted pricing.

Only Shepard Exposition Services may operate machinery. Exhibitors and their EACs may not utilize, operate, or be inside equipment.

Additional charges may be applied by Shepard due to regulations at the facility, ensuring structural integrity of sign, weight limits, union jurisdictions, facility contracts, and in house providers. Including but not limited to: spanner truss for load points, additional labor for power and/or lighting specifics, additional materials, facility pick point ceiling fees, facility and/or in house exclusive labor charges, etc. Please note: Per riggers jurisdiction, a rigging crew (up to 3 riggers) may require a 4-hour minimum to install any hanging sign, truss and/or motors, or structures requiring hoisting. Rates are per lift and crew per hour.

Step 1. Tell us about your hanging sign.

TYPE: Cloth Wood Truss Metal
 Other: _____

SHAPE: Circle Square Triangle Rectangle
 Other: _____

WEIGHT: _____

DIMENSIONS: _____ x _____

Step 2. Order assembly/disassembly labor.

Shepard Certified Riggers are required to assemble all hanging signs to ensure structural integrity.

Exhibitor Supervised

SIGN ASSEMBLY LABOR - EXHIBITOR SUPERVISED						
CODE	ITEM	EST. LABOR HOURS	ONLINE	DISCOUNT	REGULAR	TOTAL
69150	ST		\$171.56	\$197.30	\$221.00	
69151	OT		\$257.34	\$295.95	\$331.45	
69152	DT		\$343.13	\$394.60	\$441.95	

SIGN DISASSEMBLY LABOR - EXHIBITOR SUPERVISED						
CODE	ITEM	EST. LABOR HOURS	ONLINE	DISCOUNT	REGULAR	TOTAL
69153	ST		\$171.56	\$197.30	\$221.00	
69154	OT		\$257.34	\$295.95	\$331.45	
69155	DT		\$343.13	\$394.60	\$441.95	

REQUESTED DATE OF ASSEMBLY: _____

REQUESTED START TIME: _____

HOW MANY LABORERS WILL YOU REQUIRE?: _____

Should hanging sign or supervision not be present at time the crew arrives a 1 Hour Crew Minimum charge will be applied.

Labor Hours

Straight Time (ST): Monday - Friday | 8:00AM - 4:00PM.

Overtime (OT): Monday - Friday | 4:00PM - 8:00AM. All hours on Saturday.

Double Time (DT): All hours on Sunday. Holidays.

Holidays: New Years Day, Memorial Day, Independence Day, Labor Day, Thanksgiving, Christmas.

*These Holidays only apply in certain cities.

Submission of this form indicates you read and accept the Payment Policy and Terms & Conditions. Cancellations must be received in writing within 48 hours of 1st day of exhibitor move in. Equipment cancellations must be made in writing within 14 days of exhibitor move in.

COMPANY NAME: _____ BOOTH NUMBER: _____

CONTACT NAME: _____

EMAIL ADDRESS: _____



Email completed form to: orders@shepardes.com

shepardes.com

Important Information

This order form is for sign assembly/disassembly only. You will need to order rigging via the appropriate party. If Shepard is responsible for the rigging of signs, please complete the following form. If another party is handling the rigging, please order services via their forms or website.

Requested labor times are subject to availability and are not confirmed. Shepard reserves the right to change requested times in order to manage the overall installation and dismantle of the event.

Services will be charged to the exhibitor based on date and time performed. Straight time is not guaranteed. Please contact us at overheadrigging@shepardes.com with all questions.

Orders placed and diagrams submitted within 30 days of move in are subject to additional late fees.

Shepard Supervised

SIGN ASSEMBLY LABOR - SHEPARD SUPERVISED						
CODE	ITEM	EST. LABOR HOURS	ONLINE	DISCOUNT	REGULAR	TOTAL
69190	ST		\$223.03	\$256.50	\$287.30	
69191	OT		\$334.55	\$384.75	\$430.90	
69192	DT		\$446.06	\$512.95	\$574.50	

SIGN DISASSEMBLY LABOR - SHEPARD SUPERVISED						
CODE	ITEM	EST. LABOR HOURS	ONLINE	DISCOUNT	REGULAR	TOTAL
69193	ST		\$223.03	\$256.50	\$287.30	
69194	OT		\$334.55	\$384.75	\$430.90	
69195	DT		\$446.06	\$512.95	\$574.50	

REQUESTED DATE OF ASSEMBLY: _____

REQUESTED START TIME: _____

HOW MANY LABORERS WILL YOU REQUIRE?: _____

Should hanging sign or supervision not be present at time the crew arrives a 1 Hour Crew Minimum charge will be applied.

TOTAL ESTIMATE	\$ _____
TAX (All tax rates are subject to change)	6.00%
AMOUNT DUE	\$ _____

OVERHEAD RIGGING LABOR

NGAUS General Conference & Exhibition

I138120824

Huntington Place | Detroit, MI

August 24 - 26, 2024

ONLINE & DISCOUNT DEADLINE: *FRIDAY, AUGUST 2, 2024

* Order with complete Method of Payment must be received before Discount Deadline date to receive discounted pricing.

Only Shepard Exposition Services may operate machinery. Exhibitors and their EACs may not utilize, operate, or be inside equipment.

Additional charges may be applied by Shepard due to regulations at the facility, ensuring structural integrity of sign, weight limits, union jurisdictions, facility contracts, and in house providers. Including but not limited to: spanner truss for load points, additional labor for power and/or lighting specifics, additional materials, facility pick point ceiling fees, facility and/or in house exclusive labor charges, etc. Please note: Per riggers jurisdiction, a rigging crew (up to 3 riggers) may require a 4-hour minimum to install any hanging sign, truss and/or motors, or structures requiring hoisting. Rates are per lift and crew per hour.

Labor Hours

Straight Time (ST):

Monday - Friday | 8:00AM - 4:00PM.

Overtime (OT):

Monday - Friday | 4:00PM - 8:00AM. All hours on Saturday.

Double Time (DT):

All hours on Sunday. Holidays.

Holidays:

New Years Day, Memorial Day, Independence Day, Labor Day, Thanksgiving, Christmas.

**These Holidays only apply in certain cities.*

Important Information

This order form is for overhead rigging only. You will need to order sign assembly/disassembly via the previous form.

Requested labor times are subject to availability and are not confirmed. Shepard reserves the right to change requested times in order to manage the overall installation and dismantle of the event.

Services will be charged to the exhibitor based on date and time performed. Straight time is not guaranteed. Please contact us at overheadrigging@shepardes.com with all questions.

Step 1. Tell us about your hanging sign.

TYPE: Cloth Wood Truss Metal

Other: _____

SHAPE: Circle Square Triangle Rectangle

Other: _____

DIMENSIONS: Length: _____ Height: _____ Width: _____

WEIGHT: _____

Step 2. Order overhead rigging crew.

Rates are per lift and crew (up to 3 riggers) per hour. One hour minimum per lift/crew - lift/crew thereafter is charged in 1/2 increments.

Should hanging sign or supervision not be present at time the crew arrives a 1 Hour Crew Minimum charge will be applied.

OVERHEAD RIGGING INSTALLATION & REMOVAL						
CODE	ITEM	EST. LABOR HOURS	ONLINE	DISCOUNT	REGULAR	EST. TOTAL
69156	Rigging Install		\$807.00	\$928.05	\$1,039.40	
69157	Rigging Removal		\$807.00	\$928.05	\$1,039.40	

REQUESTED DATE OF INSTALL: _____ REQUESTED START TIME: _____

REQUESTED DATE OF REMOVAL: _____ REQUESTED START TIME: _____

TOTAL ESTIMATE	\$ _____
TAX (All tax rates are subject to change)	6.00%
AMOUNT DUE	\$ _____

Submission of this form indicates you read and accept the Payment Policy and Terms & Conditions. Cancellations must be received in writing within 48 hours of 1st day of exhibitor move in. Equipment cancellations must be made in writing within 14 days of exhibitor move in.

COMPANY NAME: _____ BOOTH NUMBER: _____

CONTACT NAME: _____

EMAIL ADDRESS: _____



Email completed form to: overheadrigging@shepardes.com

shepardes.com

OVERHEAD RIGGING EQUIPMENT

NGAUS General Conference & Exhibition

I138120824

Huntington Place | Detroit, MI

August 24 - 26, 2024

ONLINE & DISCOUNT DEADLINE:* THURSDAY, JULY 25, 2024

* Order with complete Method of Payment must be received before Discount Deadline date to receive discounted pricing.

Charges will apply for additional supplies required to ensure structural integrity of overhead sign.

Truss**

CODE	ITEM	QTY	ONLINE	DISCOUNT	REGULAR	TOTAL
6909415	12" Silver Box Truss (Per Ft.)		\$25.60	\$29.45	\$33.00	
6909406	12" Black Box Truss (Per Ft.)		\$25.60	\$29.45	\$33.00	
69038	12" Silver Corner Block		\$96.00	\$110.40	\$123.65	
6903806	12" Black Corner Block		\$96.00	\$110.40	\$123.65	
70067	Design Fee (Hourly)		\$208.00	\$239.20	\$267.90	

** If you are ordering truss, you also need to order motors!

Truss Details

QTY: _____ SIZE: _____

Motors

CODE	ITEM	QTY	ONLINE	DISCOUNT	REGULAR	TOTAL
69017	One Ton Hoist/Chain Motor		\$569.10	\$654.45	\$733.00	
69016	Half Ton Hoist/Chain Motor		\$505.10	\$580.85	\$650.55	
69019	Rotating Motor 500 LB Limit		\$537.10	\$617.65	\$691.75	
69020	Rotating Motor 200 LB Limit		\$313.05	\$360.00	\$403.20	

Rotate Clockwise (right) Rotate Counterclockwise (left)

Include the following items with your Truss and Motor Order:

- Hanging Sign Instructions
- Sign/Hanging Diagram
- Placement Grid
- Overhead Rigging Labor Order

TOTAL ESTIMATE	\$ _____
TAX (All tax rates are subject to change)	6.00%
AMOUNT DUE	\$ _____

ORDERS PLACED AND DIAGRAMS SUBMITTED WITHIN 30 DAYS OF MOVE IN ARE SUBJECT TO ADDITIONAL LATE FEES.

Submission of this form indicates you read and accept the Payment Policy and Terms & Conditions. No refunds or exchanges once item has been delivered to your booth. Labor Cancellations must be received in writing within 48 hours of 1st day of exhibitor move in. Equipment cancellations must be made in writing within 14 days of exhibitor move in.

COMPANY NAME: _____ BOOTH NUMBER: _____

CONTACT NAME: _____

EMAIL ADDRESS: _____



Email completed form to: overheadrigging@shepardes.com

LABOR RULES & REGULATIONS

Detroit, Michigan

LABOR

Michigan is NOT a “right-to-work” state. All exhibit and display work in the Detroit area is performed by union personnel. The following guidelines will help you in understanding the performed in each trade.

EXHIBIT LABOR JURISDICTION

Union exhibit labor claims jurisdiction for the installation, dismantling, and first cleaning of prefabricated exhibits and displays. In booths up to a 10x30, the exhibitor may erect their own display if it can be done by the exhibitor without the use of tools within two hours. If exhibitors should need Union assistance, they may be employed by completion of labor forms enclosed in this manual.

Union Labor is not required to put your products on display, to open cartons containing your products, nor to perform testing, maintenance or repairs on your products.

MATERIAL/FREIGHT HANDLING JURISDICTION

Shepard Exposition Services has the responsibility of receiving and handling all exhibit materials and empty crates that comes in via over the road carriers. It is Shepard's responsibility to manage docks and schedule vehicles for the smooth and efficient move-in and move-out of the exhibition. Shepard will not be responsible, however, for any materials they do not handle.

Exhibitors may carry in small items if these items can be hand carried by one person in one trip without the use of dollies, hand trucks, pallet jacks, or any other wheeled or mechanical item. Exhibitors may come through the front door only, all items delivered via the loading docks will be handled by union personnel and billed according to the published material handling rates.

Vehicles must not be left unattended at the loading areas. Any unattended vehicles will be towed at the owner's expense.

Arrangements have been made with Shepard Exposition Services to store empty crates. Please refer to the Material Handling Information sheet in this service manual for the handling of empties, disposal of skids, etc. Exhibitors may NOT retrieve their empty containers.

GRATUITIES /BREAKS

Tipping is expressly prohibited. This includes such practices as giving money, merchandise, or other special consideration for services rendered. Do not give coffee breaks other than mid-morning and mid-afternoon, when the union has a 15 minute paid break. Meal breaks are one hour. Any attempt to solicit a gratuity by an employee for any service should be reported immediately to Shepard Exposition Services.

IN GENERAL

Exhibitors do not have to respond to grievances or complaints from union and trade personnel with respect to work jurisdictions. Please refer all such disputes and/or questions to Shepard management personnel immediately.

SAFETY

Safety of everyone working in the hall is of our utmost concern at all times. Standing on chairs, tables and other rental furniture is prohibited. This furniture is not engineered to support your standing weight. Shepard Exposition Services cannot be held responsible for injuries or falls caused by the improper use of this furniture. If assistance is required in assembling your booth, please order labor on the Labor Order Form included in this manual and the necessary ladders and tools will be provided.

SHEPARD BLUE LABOR

NGAUS General Conference & Exhibition

I138120824

Huntington Place | Detroit, MI

August 24 - 26, 2024

ONLINE & DISCOUNT DEADLINE:* FRIDAY, AUGUST 2, 2024

* Order with complete Method of Payment must be received before Discount Deadline date to receive discounted pricing.

Labor Hours

Straight Time (ST): Monday - Friday | 8:00AM - 4:00PM.

Overtime (OT): Monday - Friday | 4:00PM - 8:00AM. All hours on Saturday.

Double Time (DT): All hours on Sunday. Holidays.

Holidays: New Years Day, Memorial Day, Independence Day, Labor Day, Thanksgiving, Christmas.

*These Holidays only apply in certain cities.

Shepard Blue Supervised Labor

INSTALL LABOR**					
CODE	ITEM	ONLINE	DISCOUNT	REGULAR	ESTIMATED TOTAL***
68066	ST	\$178.45	\$205.20	\$229.80	
68067	OT	\$267.65	\$307.80	\$344.75	
68068	DT	\$356.85	\$410.40	\$459.65	

DISMANTLE LABOR**					
CODE	ITEM	ONLINE	DISCOUNT	REGULAR	ESTIMATED TOTAL***
68070	ST	\$178.45	\$205.20	\$229.80	
68071	OT	\$267.65	\$307.80	\$344.75	
68072	DT	\$356.85	\$410.40	\$459.65	

**Pricing includes Supervisory fee of 30% over standard labor.

IN BOOTH SCISSOR LIFTS						
CODE	ITEM	EST. LABOR HOURS	ONLINE	DISCOUNT	REGULAR	TOTAL
68120	Scissor Lift Install		\$807.00	\$928.05	\$1,039.40	
68121	Scissor Lift Removal		\$807.00	\$928.05	\$1,039.40	

TOTAL ESTIMATE	\$ _____
TAX (All tax rates are subject to change)	6.00%
AMOUNT DUE	\$ _____

Step 1. Choose your service.

- Installation Dismantling Both Installation & Dismantling
 Scissor Lift Install Scissor Lift Removal Scissor Lift Install & Removal

Step 2. How many people are needed?

INSTALLATION NUMBER OF PEOPLE: _____

DISMANTLING NUMBER OF PEOPLE: _____

BOTH INSTALLATION & DISMANTLING NUMBER OF PEOPLE: _____

Step 3. How many hours?***

*** Hours are based on estimates. You will be invoiced for actual time incurred. Minimum one hour per person ordered and half increments thereafter.

INSTALLATION HOURS: _____ DISMANTLING HOURS: _____

BOTH INSTALLATION & DISMANTLING HOURS: _____

COMPANY NAME: _____ BOOTH NUMBER: _____

CONTACT NAME: _____

EMAIL ADDRESS: _____

Email completed form to: orders@shepardes.comshepardes.com

Step 4. When should the build be complete?

If using Shepard Blue Labor for both install and dismantle, please complete BOTH date and time fields.

INSTALLATION DATE: _____ INSTALLATION TIME: _____

DISMANTLING DATE: _____ DISMANTLING TIME: _____

Step 5. Tell us about your exhibit.

Section MUST be completed before Shepard can begin any work on your exhibit.

BOOTH SIZE: _____ x _____

INBOUND FREIGHT: Advanced Warehouse Direct to Show Site

CARRIER NAME: _____

TRACKING OR PRO NUMBER: _____

ESTIMATED ARRIVAL DATE: _____

NUMBER OF PIECES: _____ ESTIMATED WEIGHT: _____

SET UP INFORMATION

COMPANY CONTACT NAME: _____

EMAIL: _____

CELL PHONE NUMBER: _____

DRAWINGS/PHOTOS/INSTRUCTIONS

 Attached Emailed to Shepard With the Exhibit In Crate #: _____

GRAPHICS

 With Exhibit Shipped Separately

ELECTRICAL PLACEMENT (exhibitor is responsible to order)

 Emailed to Shepard Drawing Attached Drawing with Exhibit
 Run Under Carpet

CARPET

 Ordered from Shepard Exhibitor Owned Carpet Padding

OTHER SERVICES ORDERED

 Overhead Rigging Cleaning Audio Visual (AV)

Step 6. Tell us about outbound shipping.****

**** Allow time for empty return when scheduling your pickup.

NUMBER OF CRATES: _____ NUMBER OF CARTONS: _____

NUMBER OF FIBER CASES: _____ NUMBER OF PALLETS: _____

METHOD: Ground 2-Day Air Next Day Air Other

NAME OF CARRIER: _____

PHONE NUMBER: _____

DATE SCHEDULE TO PICKUP FREIGHT: _____

MUST ARRIVE AT DESTINATION BY: _____

IF YOUR CARRIER DOESN'T SHOW UP?

- Re-route with Shepard Logistics Service
 Send to advanced warehouse for pickup (\$400 minimum charge)

EXHIBITOR SUPERVISED LABOR

NGAUS General Conference & Exhibition

I138120824

Huntington Place | Detroit, MI

August 24 - 26, 2024

ONLINE & DISCOUNT DEADLINE:* FRIDAY, AUGUST 2, 2024

* Order with complete Method of Payment must be received before Discount Deadline date to receive discounted pricing.

Labor Hours

Straight Time (ST): Monday - Friday | 8:00AM - 4:00PM.
Overtime (OT): Monday - Friday | 4:00PM - 8:00AM. All hours on Saturday.
Double Time (DT): All hours on Sunday. Holidays.
Holidays: New Years Day, Memorial Day, Independence Day, Labor Day, Thanksgiving, Christmas.

*These Holidays only apply in certain cities.

Exhibitor Supervised Labor

INSTALL LABOR**					
CODE	ITEM	ONLINE	DISCOUNT	REGULAR	ESTIMATED TOTAL***
68060	ST	\$137.25	\$157.85	\$176.80	
68061	OT	\$205.88	\$236.75	\$265.15	
68062	DT	\$274.50	\$315.65	\$353.55	

DISMANTLE LABOR**					
CODE	ITEM	ONLINE	DISCOUNT	REGULAR	ESTIMATED TOTAL***
68063	ST	\$137.25	\$157.85	\$176.80	
68064	OT	\$205.88	\$236.75	\$265.15	
68065	DT	\$274.50	\$315.65	\$353.55	

** When ordering dismantle labor, due to show break down and returning empties to your booth, labor ordered through Shepard at the close of the event may not be available until one hour after show close.

TOTAL ESTIMATE	\$ _____
TAX (All tax rates are subject to change)	6.00%
AMOUNT DUE	\$ _____

Step 1. Choose your service.

Installation Dismantling Both Installation & Dismantling

Step 2. How many people are needed?

INSTALLATION NUMBER OF PEOPLE: _____

DISMANTLING NUMBER OF PEOPLE: _____

BOTH INSTALLATION & DISMANTLING NUMBER OF PEOPLE: _____

Step 3. How many hours?***

*** Hours are based on estimates. You will be invoiced for actual time incurred. Minimum one hour per person ordered and half increments thereafter.

INSTALLATION HOURS: _____ DISMANTLING HOURS: _____

BOTH INSTALLATION & DISMANTLING HOURS: _____

Step 4. Where is the carpet coming from?

Ordered from Shepard Exhibitor Owned Carpet Padding

Step 5. Provide a list of any tools or additional details that would be needed.

Ladders Lifts Special Tools: _____

ADDITIONAL DETAILS: _____

Step 6. Tell us about the schedule?

Requested times are not guaranteed and are based on availability.

INSTALLATION REQUEST DATE: _____

START TIME: _____ END TIME: _____

DISMANTLE REQUEST DATE: _____

START TIME: _____ END TIME: _____

Step 7. Provide on-site contact information.

ON-SITE CONTACT NAME: _____

ON-SITE CONTACT PHONE NUMBER: _____

EMAIL ADDRESS: _____

Signature and submission of this form indicates you read and accept the Payment Policy and Terms & Conditions. Orders canceled without 48-hour written notice will be charged a one (1) hour cancellation fee.

COMPANY NAME: _____ BOOTH NUMBER: _____

CONTACT NAME: _____ PHONE NUMBER: _____

EMAIL ADDRESS: _____



Email completed form to: orders@shepardes.com

Guidelines for Display Rules and Regulations

Updated for NGAUS

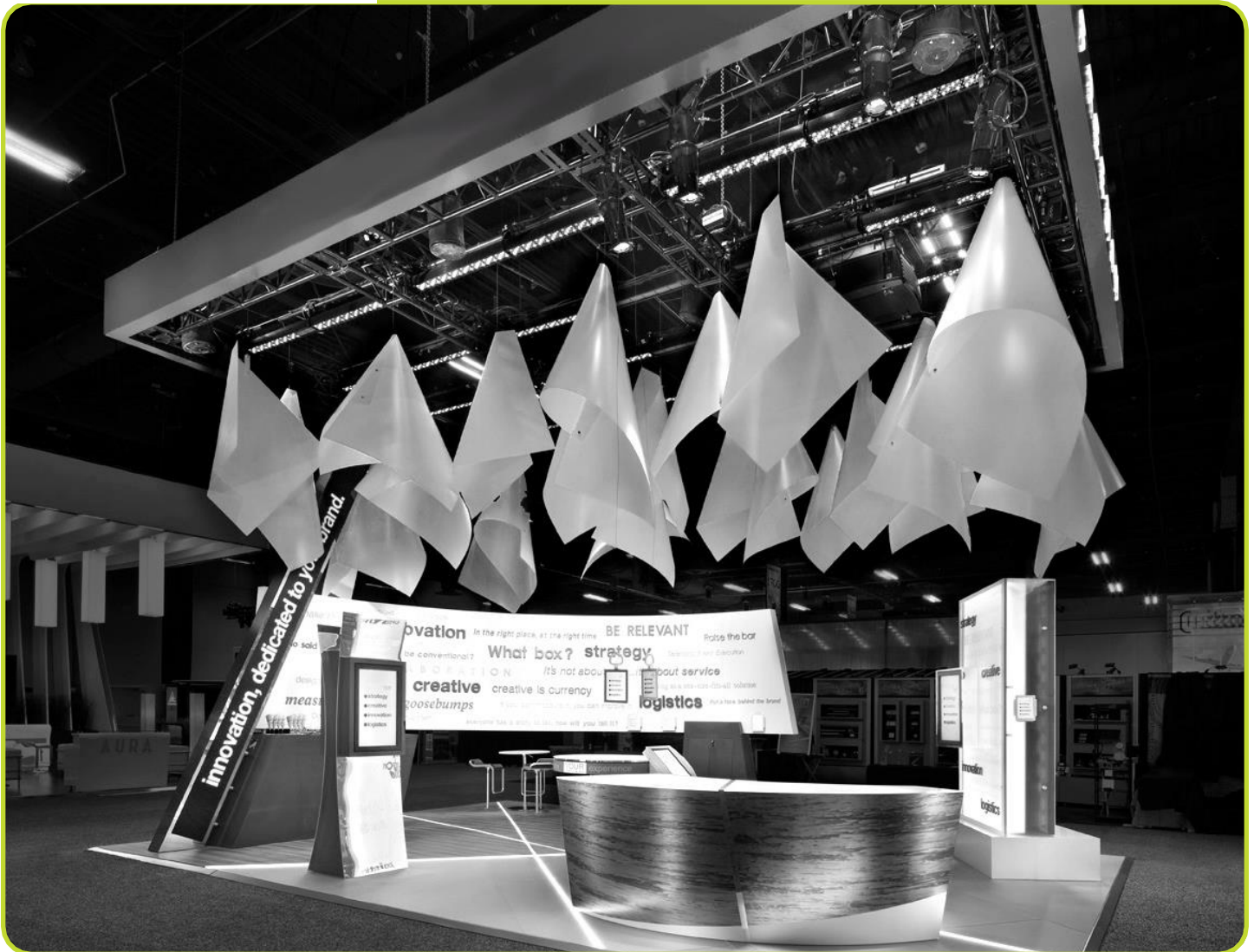

Made possible by a generous grant from

Freeman

The following ***Guidelines for Display Rules and Regulations*** have been established by the International Association of Exhibitions and Events® (IAEE) to assist in promoting continuity and consistency among North American exhibitions and events. This revised 2023 edition is offered as a resource for exhibition and event organizers to use in creating consistent and fair exhibiting standards for their events.

Recognizing that every show is unique, IAEE presents the information contained within as recommendations or suggestions for exhibiting standards each Organizer should consider. Organizers are encouraged to review the ***Guidelines*** and then develop their own show-customized set of exhibiting rules and regulations based on the individual features of their specific exhibition or event.

Once an Organizer has finalized their show's official set of display rules, it is good practice to provide access to a digital copy within the show's exhibitor prospectus, an exhibitor services kit, and the official rules and regulations pertaining to exhibitor participation. By providing exhibitors with the professional standards expected of their displays and participation, they will be prepared to properly design, build and plan their booth's layout and content allowing for an environment where all exhibitors will have the opportunity for successful interaction with their audiences.

Important Note: Although compliance with fire, safety, the U.S. Americans with Disabilities Act (ADA), and other state, federal or provincial government requirements have been addressed, Organizers should always check with exhibition service contractors and the facility for specific details on local regulations and requirements.

*IAEE is a global association that serves as the foremost authority on exhibitions and events management and operations, and these **Guidelines** are the model for most North American exhibitions and events but in all instances, organizations should consult their legal counsel. In no event shall IAEE be held liable for damages of any kind in connection with the material, methods, information, techniques, opinions or procedures expressed, presented, or illustrated in these **Guidelines** or related materials.*



International
Association of
Exhibitions and Events®

TABLE OF CONTENTS

LINE-OF-SIGHT STYLE	1
Linear or In-line Booth	1
Dimensions	1
Use of Space	1
Corner Booth.....	2
Perimeter Booth	2
Dimensions and Use of Space	2
End-cap Booth	3
Dimensions and Use of Space	3
Peninsula Booth.....	4
Dimensions and Use of Space	4
Split Island Booth.....	5
Dimensions and Use of Space	5
Island Booth	6
Dimensions and Use of Space	6
Extended Header Booth 20ft (6.10m) or Longer	7
Dimensions and Use of Space	7
Remote-Controlled Devices	8
OTHER IMPORTANT CONSIDERATIONS	8
Canopies and Ceilings	9
Structures and Tie-Offs	10
Structures.....	10
Tie-offs	10
Hanging Signs and Graphics	10
Teardrop Signs and Tents.....	10
Truss	11
Video Displays	11
Towers and Multi-story Exhibits	11
U.S. Americans with Disabilities Act (ADA).....	11

TABLE OF CONTENTS

ISSUES COMMON TO ALL BOOTH TYPES 11

- Structural Integrity 12
- Flammable and Toxic Materials 12
- Hazardous Waste..... 12
- Storage..... 12
- Electrical..... 13
- Lighting..... 13
- Demonstrations 14
- Sound/Music 14
- Vehicles (For Both Gas and Electric Vehicles) 15
- Fire Equipment..... 15
- Hanging Signs..... 15

ADVISORY NOTES TO EXHIBITION ORGANIZERS 15

- Hardwall Booths..... 16
- Perimeter Openings 16
- Pipe and Drape 16
- Product Height 16
- Height Variances..... 16
- Environmental Responsibility 16

APPENDIX 17

IAEE EXTENDS A SPECIAL THANK YOU TO THE FOLLOWING VOLUNTEERS FOR THEIR INPUT..... 28

IAEE has identified two distinctly different styles of show display regulations. One style is “Line-of-Sight” while the second is “Cubic Content.” Organizers should decide which style is best suited to their event or designated section of the event. Organizers might find line of sight rules are best for linear booths and cubic content rules for configurations of island, peninsula or perimeter booths.

LINE-OF-SIGHT

Line-of-Sight display rules provide restrictions on certain areas of booths to allow attendees to view neighboring booths in their line of sight as they walk the floor. There are a variety of booth types, and each one is addressed below with specific insight on how to implement Line-of-Sight regulations.

LINEAR OR IN-LINE BOOTH

services easily seen by attendees as they walk the aisles is essential to all exhibitors, and that is the basis for including a Linear Booth Line-of-Sight setback rule. Linear Booths, also called “in-line” booths, are generally arranged in a straight line and have neighboring exhibitors on their immediate right and left, leaving only one side exposed to the aisle.

Dimensions

For purposes of consistency and ease of layout and/or reconfiguration, floor plan design in increments of 10ft (3.05m) has become the de facto standard in the United States. Therefore, unless constricted by space or other limitations, Linear Booths are most

commonly 10ft (3.05m) wide and 10ft (3.05m) deep, i.e. 10ft by 10ft (3.05m by 3.05m). A maximum back wall height limitation of 8ft (2.44m) is specified to prevent display materials from imposing on neighboring exhibits behind the back wall.

Use of Space

Regardless of the number of Linear Booths utilized, e.g. 10ft by 20ft (3.05m by 6.10m), 10ft by 30ft (3.05m by 9.14m), 10ft by 40ft (3.05m by 12.19m), etc., display materials should be arranged in such a manner so as not to obstruct sight lines of neighboring exhibitors. The maximum height of 8ft (2.44m) is allowed only in the rear half of the booth space, with a 4ft (1.22m) height restriction imposed on all materials in the remaining space forward to the aisle. Note: When three or more Linear Booths are used in combination as a single exhibit space, the 4ft (1.22m) height limitation is applied only to that portion of exhibit space which is within 10ft (3.05m) of an adjoining booth.

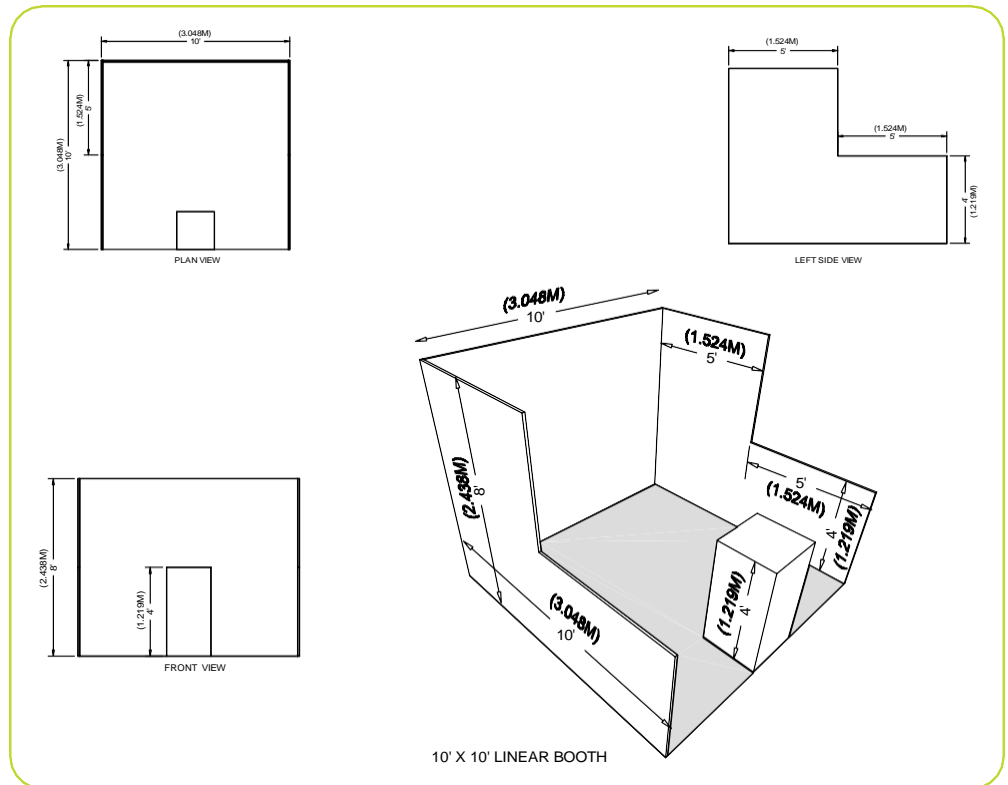

CORNER BOOTH

A Corner Booth is a Linear Booth at the end of a series of in-line booths with exposure to intersecting aisles on two sides. All guidelines for Linear Booths apply.

PERIMETER BOOTH

A Perimeter Booth is a Linear Booth that backs to an outside wall of the exhibit facility rather than to another exhibit.

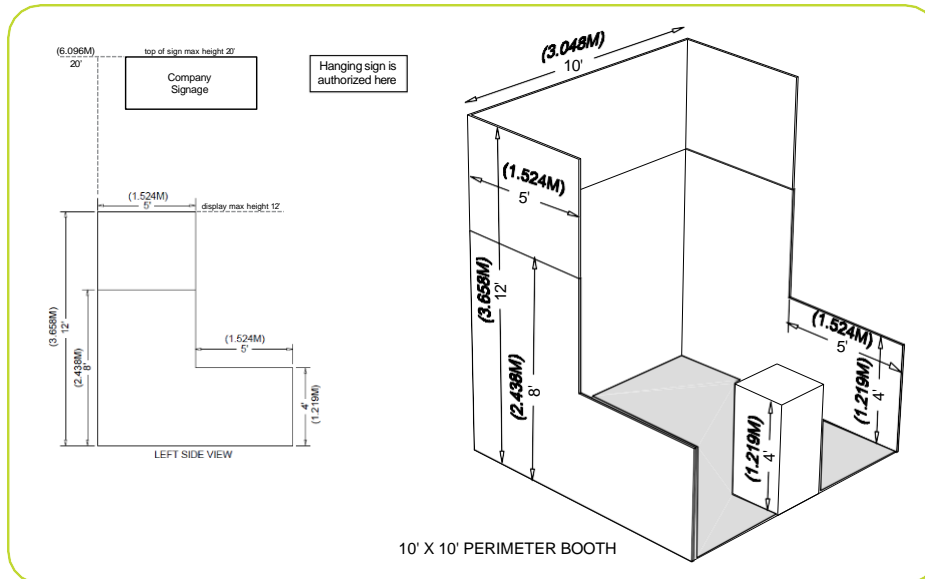

Dimensions and Use of Space

All guidelines for Linear Booths apply to Perimeter Booths except that the typical maximum back wall height for Perimeter Booths is 12ft (3.6m).

END-CAP BOOTH

An End-cap configuration is essentially an in-line (linear) booth placed in the position of a Peninsula or Split Island. For shows that have Line-of-Sight rules and not Cubic Content, this configuration must follow the dimensions below. Organizers should be alert to exhibitors reserving End-cap configurations to ensure they do not violate Linear Booth Line-of-Sight regulations for neighboring exhibits. (In most cases, this booth style is not recommended due to the Line-of-Sight issues, and Organizers should be aware of these challenges when using them.)

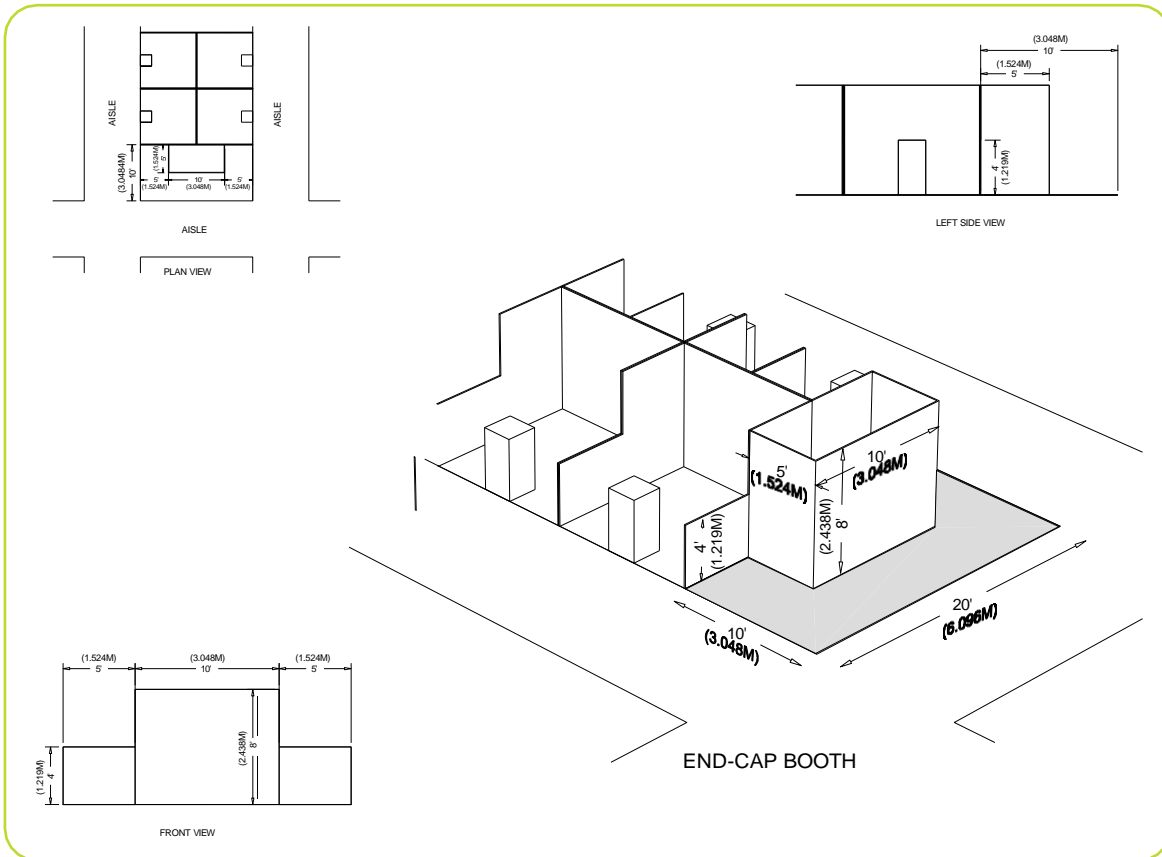

Dimensions and Use of Space

End-cap Booths are generally 10ft (3.05m) deep by 20ft (6.10m) wide. The maximum back wall height allowed is 8ft (2.44m) and the maximum backwall width allowed is 10ft (3.05m) at the center of the backwall with a maximum 5ft (1.52m) height on the two side aisles. Within 5ft of the two side aisles, the maximum height for any display materials is 4ft.

PENINSULA BOOTH

A Peninsula Booth is exposed to aisles on three sides. There are two types of Peninsula Booths: (a) one which backs to Linear Booths, and (b) one which backs to another Peninsula Booth which is referred to as a “Split Island Booth.”

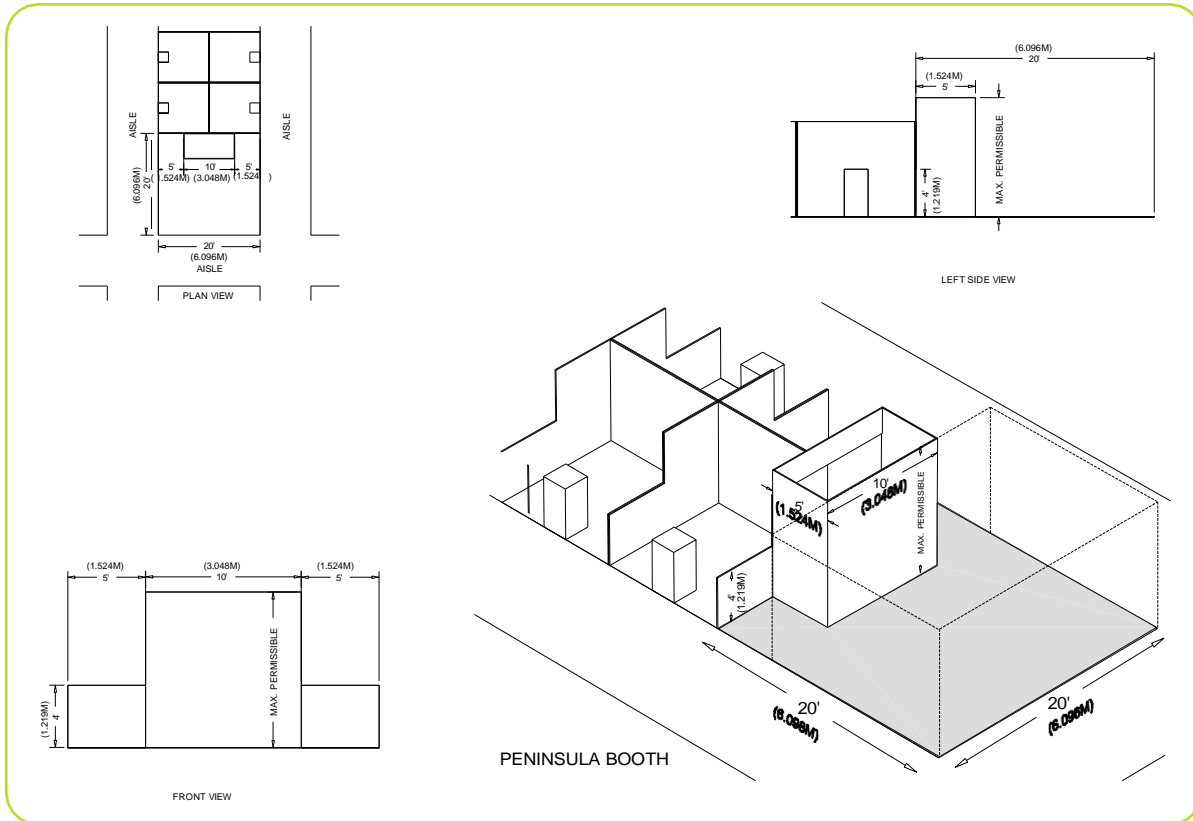

Dimensions and Use of Space

A Peninsula Booth is usually 20ft by 20ft (6.10m by 6.10m) or larger. When a Peninsula Booth backs up to two Linear Booths, the back wall is restricted to 4ft (1.22m) high within 5ft (1.52m) of each aisle, permitting adequate line of sight for the adjoining Linear Booths. A typical maximum height range allowance is 16ft to 20ft (4.88m to 6.10m), including signage for the center portion of the back wall. Double-sided signs, logos and graphics shall be set back 10ft (3.05m) from adjacent booths.

SPLIT ISLAND BOOTH

A Split Island Booth is a Peninsula Booth which shares a common back wall with another Peninsula Booth.

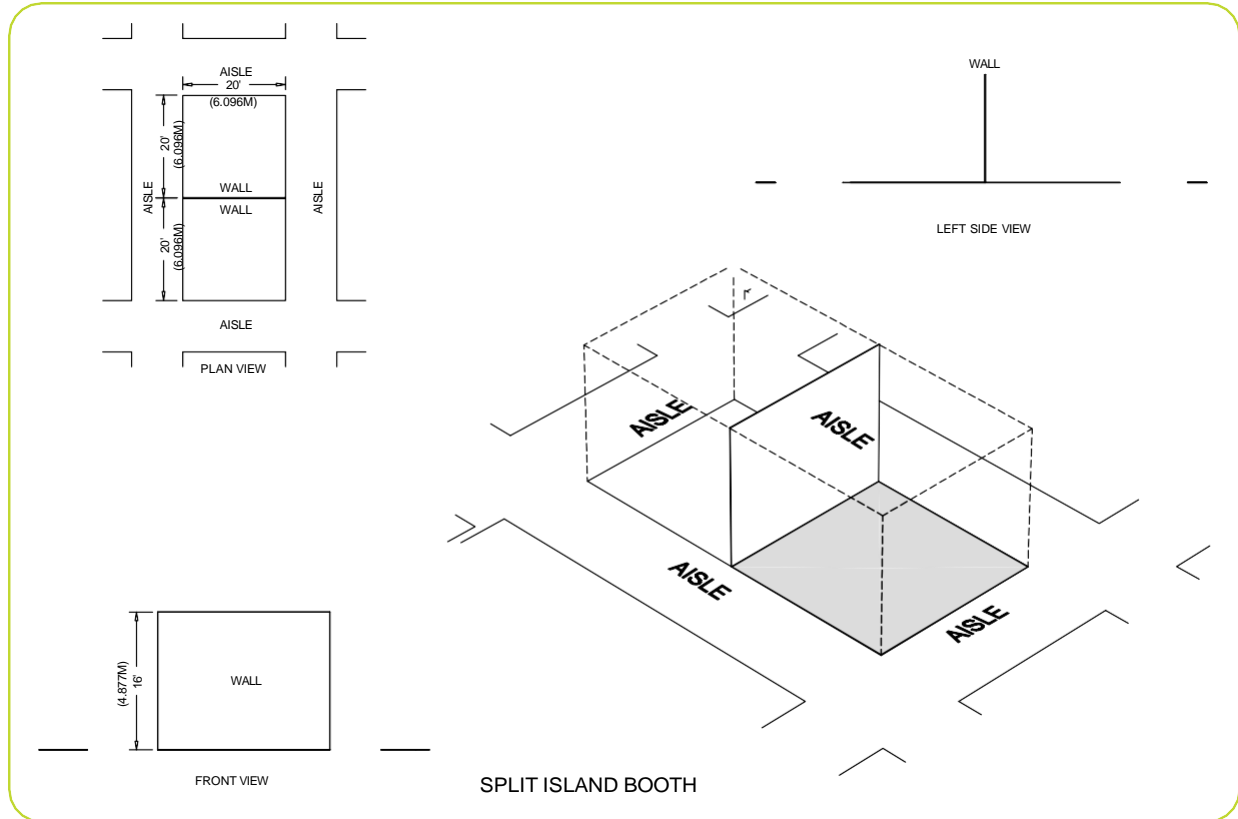

Dimensions and Use of Space

The entire Cubic Content of this booth may be used, up to the maximum allowable height, without any back wall Line-of-Sight restrictions. A typical maximum height range allowance is 16ft to 20ft (4.88m to 6.10m), including signage. The entire Cubic Content of the space may be used up to the maximum allowable height. Double-sided signs, logos and graphics shall be set back 10ft (3.05m) from adjacent booths.

For large shows with big exhibitors, it may be difficult to maintain the entire booth and hanging sign to be within 16ft. If you make it 20 ft then you run the risk of lots of large booths (with or without signs) being 20 ft and dwarfing all around them. That is fine as long as everyone is aware of it. An alternative could be to offer a max booth height of 16 ft and each exhibitor must have a 4 ft gap between the top of the booth and the bottom of the hanging sign. The only exception is if the booth and hanging sign can stay below 16ft. It is far from perfect but does allow at least the ability to see through a booth.

ISLAND BOOTH

An Island Booth is any size booth exposed to aisles on all four sides.

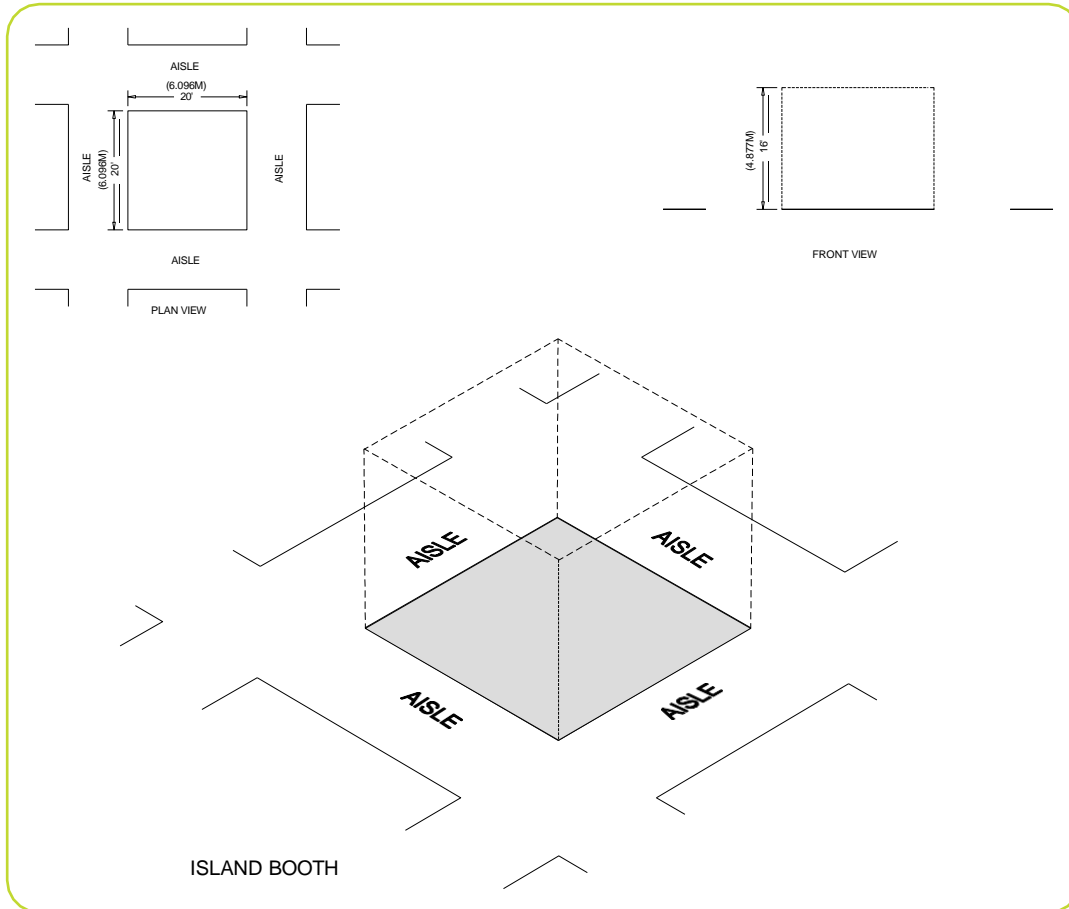

Dimensions and Use of Space

An Island Booth is typically 20ft by 20ft (6.10m by 6.10m) or larger, although it may be configured differently. Island booths should not be allowed at less than 400 sq ft. Island booths at 200 or 300 sq ft basically result in frustrating everyone behind them. The entire Cubic Content of the space may be used up to the maximum allowable height, which is usually a range of 16ft to 20ft (4.88m to 6.10m), including signage.

EXTENDED HEADER BOOTH 20FT (6.10M) OR LONGER

An Extended Header Booth is a Linear Booth 20ft (6.10m) or longer with a center

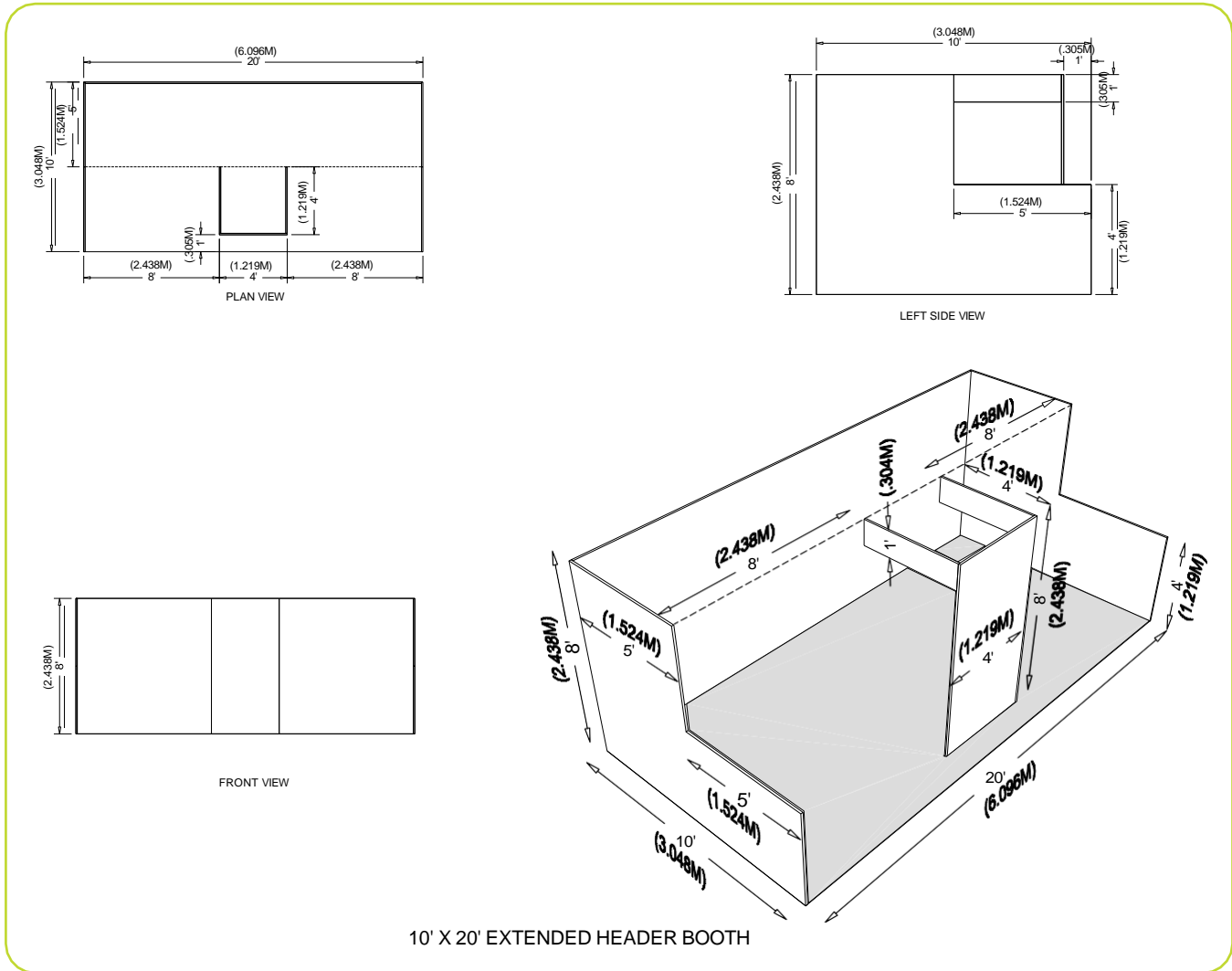

Dimensions and Use of Space

All guidelines for Linear Booths apply to Extended Header Booths, except that the center extended header has a maximum height of 8ft (2.44m), a maximum width of 20 percent of the length of the booth, and a maximum depth of 9ft (2.7m) from the back wall.

OTHER IMPORTANT CONSIDERATIONS

REMOTE-CONTROLLED DEVICES

Products such as remote-controlled cars, drones, planes, helicopters, robots, etc. are to be demonstrated in a safely controlled area of the exhibit floor (i.e. Demonstration Area). When a remote-controlled device is to be used for the purpose of demonstrating a product that requires use of an area outside of the exhibitor-assigned booth space, the Organizer will provide a Demonstration Area for this purpose. The Demonstration Area should include safe netting or other barrier appropriate to accommodate product(s) being demonstrated and be included on the master floor plan submitted for Fire Marshal approval. Each individual facility reserves the right to determine what constitutes a safe and controlled Demonstration Area prior to final plan approval.

NOTE for Drone Operation: Local facility and city ordinances are in effect in most areas and prohibit drone activity near the public or in public spaces. The accepted drone default regulation is the [FAA Small UAS Rule Part 107](#) which requires drone operators to obtain a Remote Pilot Certificate. Commercial regulations often require permits and insurance.

CANOPIES AND CEILINGS

A canopy sign is similar to an awning on a building, except it does not include the goal of providing shelter. It extends from a booth to serve the function as a marquee. Canopies, including ceilings, umbrellas and canopy frames, can be either decorative or functional (such as to shade computer monitors from ambient light or to allow for hanging products). Canopies for Linear or Perimeter Booths should comply with Line-of-Sight requirements. (See "Use of Space" for Linear or Perimeter Booths, and height limits).

The bottom of the canopy should not be lower than 7ft (2.13m) from the floor within 5ft (1.52m) of any aisle. Canopy supports should be no wider than three inches 3in (.08m). This applies to any booth configuration that has a sight line restriction, such as a Linear Booth. Fire and safety regulations in many facilities strictly govern the use of canopies, ceilings and other similar coverings. Check with the appropriate local agencies prior to determining specific exhibition rules.

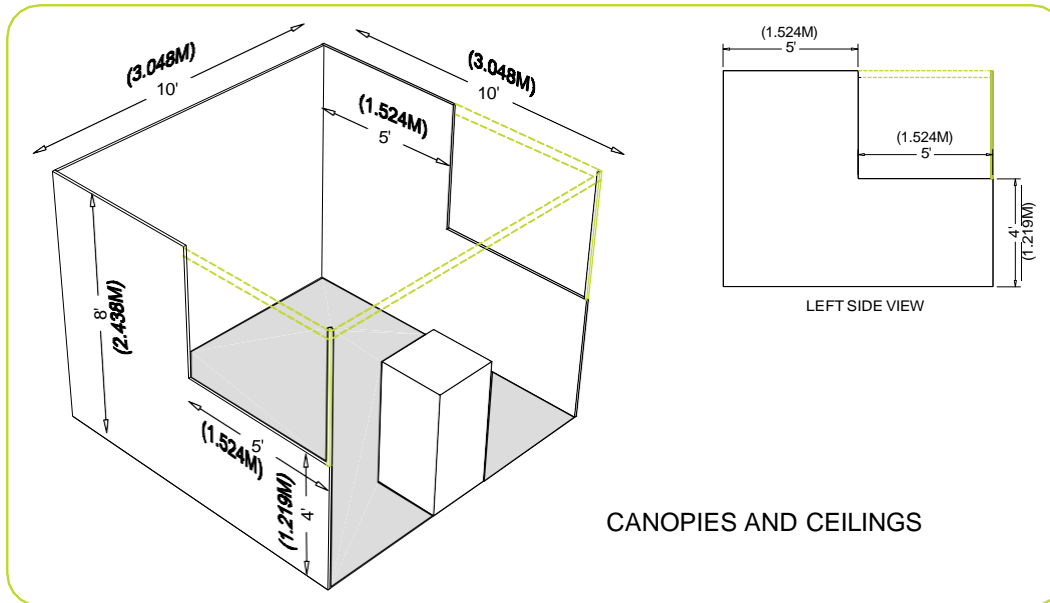

STRUCTURES AND TIE-OFFS

Structures

Show Organizer requires a stamped certification from a design professional (Civil or Structural Engineer) registered in the state where the Event will be held affirming all calculations and specifications for any custom-built suspended elements such as but not limited to non-serially manufactured signs, lightboxes, headers, video wall surrounds, and entry portals. For additional assistance regarding these requirements, please reach out to the rigging vendor.

Tie-offs

Show Organizer reserves the right to request a stamped certification from a design professional (Civil or Structural Engineer) registered in the state where the Event will be held affirming all calculations and specifications and/or a peer review from such registered design professional for attachment of any structure to provide additional support terminating to the venue (Ex. Tie-ff of header, seismic lines, tie-ff of video walls). If you anticipate needing this service, please reach out to the rigging vendor review and pre-authorization.”

HANGING SIGNS AND GRAPHICS

Most exhibition and event rules allow for Hanging Signs and Graphics in all standard Peninsula and Island Booths, usually to a maximum height range of 16ft to 20ft (4.88m to 6.10m) from the top of the sign, or as determined by the Organizer. End-cap Booths do not qualify for Hanging Signs and Graphics. The distance is measured from the floor to the top of the sign. Whether suspended from above, or supported from below, they should comply with all ordinary use-of-space requirements. For example, the highest point of any sign should not exceed the maximum allowable height for the booth type. (An exception to this rule is made for Perimeter Booths, which can have a 12ft [3.66m] backwall but max sign height can be 20ft. [6.10m]. See page 2 Perimeter Booth for diagram.)

Hanging Signs and Graphics should be set back 10ft (3.05m) from adjacent booths and be directly over contracted space only.

Approval for the use of Hanging Signs and Graphics, at any height, should be received from the Organizer at least 60 days prior to installation. Variances may be issued at the Organizer’s discretion. Drawings should be available for inspection.

Sign Hanging Points must be engineered, and the hardware must be domestic, forged, shouldered, rated, and stamped with Working Load Limit (WLL). All overhead rigging must comply with facility and show management regulations. The official contractor and/or facility will require an engineered print of all truss and lighting rigging including rigging point loads, as well as any ground supported truss structures or LED video walls. . All submitted files should be in DWG format. This information is typically required at least three weeks out from the first day of move-in of an event. Electrical signs must be in working order and in accordance with the National Electrical Code. If any hang point exceeds 200 lbs. please notify the official contractor for official authorization.

TEARDROP SIGNS AND TENTS

Placement of Teardrop flags must be positioned in the back ½ of all linear booths.

Tents – must have no copy on the sides or back side and not exceed 8ft height limit. I would also specifically address the tents with extended ceilings, see below. Under no circumstances are these acceptable in a linear booth regardless of whether they have copy or not.

TRUSS

Truss is a frame used to carry a cover over a booth or suspend lighting or technical equipment over a booth. Some shows will allow to go over the height limit but require plans to the organizer and service contractor for approval.

VIDEO DISPLAYS

Show Organizer reserves the right to request approval from a registered design professional (Civil or Structural Engineer) and/ or a peer review from a registered design professional for all non-serially manufactured LED and Video Display systems. All LED and video display systems must comply to ANSI E1.50-1. This applies to ground supported and suspended LED and Video Display systems. If you anticipate needing this service, please reach out to your rigging vendor.

TOWERS AND MULTI-STORY EXHIBITS

A Tower is a free-standing exhibit component separate from the main exhibit fixture. The height restriction is the same as that which applies to the appropriate exhibit space configuration being used. Fire and safety regulations in many facilities strictly govern the use of Towers. A building permit or safety lines may be required.

A Multi-story Exhibit is a booth where the display fixture includes two or more levels. In many cities, a Multi-story Exhibit requires prior approval by the exhibit facility, and/or relevant local government agency, as well as the Organizer because it is deemed to be a “structure” for building purposes. The city building department generally needs to issue a building permit based on an application and drawings prepared and submitted by a licensed architect or engineer. Exhibitors should obtain local building regulations early on to ensure that all time constraints are met. Organizers should be prepared to assist exhibitors in this application process.

It is recommended that Organizers require exhibitors to provide engineering stamped documents for all Multi-story Exhibits and towers over 8ft (2.44m) in height. If engineering stamps are not required, exhibitors using these types of structures should, at a minimum, provide drawings for inspection.

ISSUES COMMON TO ALL BOOTH TYPES

U.S. AMERICANS WITH DISABILITIES ACT (ADA)

In the U.S., all exhibiting companies are required to be in compliance with the U.S. Americans with Disabilities Act (ADA), and are encouraged to be sensitive, and as reasonably accommodating as possible, to attendees with disabilities. Information regarding ADA compliance is available from the U.S. Department of Justice ADA Information Line (800) 514-0301, and from the ADA website at www.ada.gov.

Some examples of how to design an exhibit for ADA compliance:

- Make exhibits wheelchair accessible by ramping raised exhibit flooring without extending a ramp into the aisle. Note: a standard wheelchair ramp should have a grade no steeper than 1:12. This means that for every inch of rise (change in height), there should be 12 inches of run (change in length). Ramps should have a minimum width of 36 inches.
- Ramp the entry or use hydraulic lifts to trailer exhibits.
- Avoid double-padded plush carpet to ease mobility device navigation.
- Provide the same attendee experience on both levels of a two-story exhibit.

- Offer a signer or other auxiliary hearing-impaired apparatus for sound presentations or have a printed copy of the presentation available.
- Run an audio presentation for people with sight problems.
- Arrange touch screen displays at a height to accommodate a person sitting in a wheelchair.

To avoid potential fines by the U. S. Department of Justice, exhibitors must adhere to the ADA rules. Exhibits are not exempt from ADA compliance.

STRUCTURAL INTEGRITY

All exhibit displays should be designed and erected in a manner that will withstand normal contact or vibration caused by neighboring exhibitors, hall laborers, or installation/dismantling equipment, such as fork lifts. Displays should also be able to withstand moderate wind effects that may occur in the exhibit hall when freight doors are open. Refer to local building codes that regulate temporary structures.

It is recommended that all exhibits 20ft by 20ft (6.10m by 6.10m) and larger require a drawing, plans or renderings, preferably digital, to be submitted to the Organizer, and to the show's Official Services Contractor for approval.

Exhibitors should ensure that any display fixtures such as tables, racks, or shelves are designed and installed properly to support the product or marketing materials to be displayed.

FLAMMABLE AND TOXIC MATERIALS

All materials used in display construction or decorating should be made of fire retardant materials and be certified as flame retardant. Samples should also be available for testing. Materials that cannot be treated to meet the requirements should not be used. A flame-proofing certificate should be available for inspection. Exhibitors should be aware of, and must adhere to, all local regulations regarding fire/safety and environment.

Exhibitors should dispose of any waste products they generate during the exhibition in accordance with guidelines established by the

U.S. Environmental Protection Agency, or the appropriate government entity in the country the exhibition will be held, and the facility.

HAZARDOUS WASTE

Hazardous waste requires special arrangements to be prepared in advance of event dismantle with either the facility or a local independent disposal company. Exhibitors are responsible for all costs associated with such specialized removal.

STORAGE

Fire regulations in most exhibit facilities prohibit storing product, literature, empty packing containers, or packing materials behind back drapes or under draped tables. In most cases, however, exhibitors may store a limited supply of literature or product appropriately within the booth area, as long as these items do not impede access to utility services, create a safety problem, or look unsightly.

ELECTRICAL

Every exhibit facility has different electrical requirements and rules regarding who is permitted to provide equipment and labor; however, minimum guidelines are suggested:

- All 110-volt wiring should be grounded three-wire.
- Wiring that touches the floor should be “SO” cord (minimum 14-gauge/three-wire) flat cord, which is insulated to qualify for “extra hard usage.” It is particularly important for exhibitors to use flat electrical cord in under-carpet installations.
- Cord wiring above floor level can be “SJ” which is rated for “hard usage.”
- Using zip cords, two-wire cords, latex cords, plastic cords, lamp cords, open clip sockets, and two-wire clamp-on fixtures is not recommended and is often prohibited. Cube taps should be prohibited.
- Power strips (multi-plug connectors) should be UL approved, with built-in over-load surge protectors.
- Local code commonly requires access to electrical cords and connections along the back wall of exhibit booths; typically, the back 9 inches of the space should remain accessible for this purpose. (This would apply to all booth types with a back wall.)

To better understand electrical at exhibitions, see the CEIR article [Demystifying Electrical Services for the Exhibitor](#).

LIGHTING

It is important to remember that lighting issues need to be identified as early as possible during the move-in process so they can be addressed and corrected while the necessary equipment is still available on the show floor and booths can be accessed.

- No lighting, fixtures, lighting trusses, or overhead lighting are allowed outside the boundaries of the exhibit space. Exhibitors intending to use hanging light systems should submit drawings to the Organizer for approval.
- Lighting should not project onto other exhibits or exhibition aisles. Lighting, including gobos, should be directed to the inner confines of the booth space.
- Lighting that is potentially harmful, such as lasers, ultraviolet lights or flashing or strobe lights that can trigger photosensitive epilepsy should comply with facility rules and be approved in writing by the Organizer.
- Lighting that spins, rotates, pulsates, and other specialized lighting effects should be in good taste and not interfere with neighboring exhibitors or otherwise detract from the general atmosphere of the event.
- LED lights can be very bright yet generally generate less heat.
- Currently, some convention facilities are not allowing certain types of quartz halogen lighting fixtures in exhibits due to potential fire hazards.
- Reduced lighting for theater areas should be approved by the Organizer, the utility provider, and the

DEMONSTRATIONS

As a matter of safety and courtesy to others, exhibitors should conduct sales presentations, product demonstrations, press conferences and other media events in a manner which assures all exhibitor personnel and attendees of such in-booth events are within the contracted exhibit space and not encroaching on the aisles or neighboring exhibits. Any queue lines formed for exhibitor customer interaction must also be contained within the booth footprint. It is the responsibility of each exhibitor to arrange displays, product presentation, audio visual presentations, and demonstration areas to ensure compliance with all other previously listed rules and regulations. Exhibitors should be aware of, and adhere to, local regulations regarding fire/safety and environment.

Special caution should be taken when demonstrating machinery or equipment that has moving parts, cooking equipment with an open flame, or any product that is otherwise potentially dangerous. Exhibitors should establish a minimum setback of 3ft (.91m) and/or install hazard barriers as necessary to prevent accidental injury to spectators. Additionally, demonstrations should only be conducted by qualified exhibitor personnel.

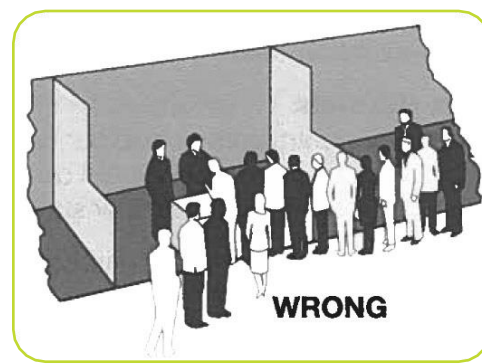
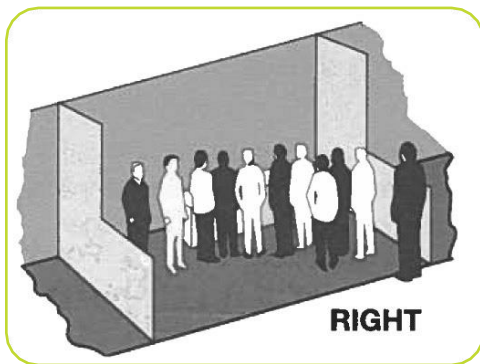

SOUND/MUSIC

In general, the use of sound equipment in booths is permitted as long as the noise level does not disrupt the activities of neighboring exhibitors. Speakers and other sound devices should be positioned to direct sound inward (to be contained within the booth) rather than outward (toward aisles and other exhibitor booths). Generally, sound and noise should not exceed 85 decibels when measured from the aisle immediately in front of a booth. If an exhibitor or attendee is standing within ten feet of an exhibitor's booth and cannot carry on a normal voice-level conversation, the noise source is too loud. (Refer to the U.S. Occupational Safety and Health Act [OSHA] at www.osha.gov for more information.)

Exhibitors should be aware that music played in their booths, whether live or recorded, may be subject to laws governing the use of copyrighted compositions. Authorized licensing organizations, including but not limited to [ASCAP](http://www.ascap.com), [BMI](http://www.bmi.com) and [SESAC](http://www.sesac.com), collect copyright fees on behalf of composers and publishers of music. It is the exhibitors' responsibility to be informed of copyright laws and submit fees to the appropriate organizations.

VEHICLES (FOR BOTH GAS AND ELECTRIC VEHICLES)

Rules for display vehicles vary widely depending on the facility and local fire and safety regulations. Compliance with fire, safety, the U.S. Americans with Disabilities Act (ADA), and other city, county, federal, and provincial government requirements is the responsibility of the Organizer.

Important Note: Always check with local exhibition service contractors and/or the facility for all requirements regarding display vehicles. Below are a few common examples of display vehicle regulations:

- Display vehicles must have battery cables disconnected and taped, and alarm systems deactivated.
- Fuel tank openings shall be locked or sealed in a manner to prevent escape of vapors through filler caps.
- Vehicles shall be limited in the amount of fuel that can remain in the tanks; specific amounts vary but one example is no more than one-quarter the tank capacity or a maximum of five gallons of fuel, whichever is less.
- Fueling or de-fueling of vehicles on the facility premises is prohibited.
- Once placed, display vehicles may not be started or moved without the approval and direction of show management.
- Auxiliary batteries not connected to engine starting system may remain connected. External power is recommended for demonstration purposes. No battery charging is permitted inside buildings.
- Combustible/flammable materials must not be stored beneath display vehicle. There may be no leaks underneath vehicles.
- It is not recommended that Organizers hold or take possession of display vehicle keys during the event. However, it is recommended that an official policy be established for the handling of vehicle keys which might include identifying booth contacts with mobile numbers should vehicles need to be moved in an emergency or some other unforeseen situation. Need to get guidelines for placing, displaying electric vehicles.
- Check with your facility regarding any weight load limits.
- Show organizers should request information from exhibitors in advance of the show if they are bringing in a vehicle Usually 45 days is the standard.

ADVISORY NOTES TO EXHIBITION

FIRE EQUIPMENT

Fire hoses, extinguishers, and audible or visual devices for fire alarms should be visible and accessible at all times.

HANGING SIGNS

Although these Guidelines indicate 16ft to 20ft (4.88m to 6.10m) as a maximum height range to the top of the sign, some exhibitions permit other heights, or have no height limit. However, most Organizers do impose height limits. Caution should be exercised so exhibitors will not compete over air space for

Exhibitors should be advised to install “hanging points” at the time of manufacture of the sign or display. It is also advisable to have Hanging Signs labeled and cased separately so that they can be easily identified on-site as they usually must be installed before other exhibit construction can begin.

Recommend checking with facilities regarding some areas of exhibit hall that may not have points available to alert exhibitors.

HARDWALL BOOTHS

Exhibitions that provide Hardwall Booths should specify if these structures can be used for display and attaching products.

PERIMETER OPENINGS

Local fire and/or facility regulations may require larger exhibit booths to have a certain number of openings within the perimeter walls for safe egress. Regulations vary with each location, but one example would be to provide, at a minimum, one 6ft (1.83m) wide opening every 30ft (9.14m).

PIPE AND DRAPE

These are commonly used at exhibitions and events in the United States to define exhibit space. Organizers also may note which size booths and configurations will be provided with pipe and drape. Organizers often include in their rules and regulations that this equipment is not intended as a display fixture. Therefore, product and signs should not be attached or affixed. Measurements of booths must allow for size of pipe on sides and back.

PRODUCT HEIGHT

Some exhibitors have products that exceed display height restrictions. Organizers should establish guidelines for displaying such products. For example, some exhibitions or events require that these exhibitors reserve only perimeter space. Products exceeding height restrictions for Islands and Peninsulas are usually permitted, providing they are displayed in operating mode, and the names and logos, etc. on the product are as it is sold. NOTE: Any special height variances allowed should apply only to those products represented, produced or manufactured by the exhibitor and would not apply to ancillary display or marketing items (such as promotional flags, signs, etc.).

HEIGHT VARIANCES

Height Variances may be issued for all types of booths. However, in a Linear Booth, the back side of any structure over 8ft (2.44m) must be free of trademarks, graphics and/or logos. Tall flags or markers on the front aisle of Linear Booths are prohibited. Pop up tents or canopies may be allowed but must follow all local fire and facility regulations.

ENVIRONMENTAL RESPONSIBILITY

Exhibitions and events, by their very nature, create waste. Properly managed, exhibitions and events can recycle excess materials and supplies in useful and meaningful ways, and they can do so using methods that result in minimized impact on the environment. Exhibits should utilize recycled, renewable and energy efficient materials whenever possible. Exhibitors planning to dispose of, or leave behind, any property from their booth must make arrangements with the Official Services Contractor for disposal and all appropriate and applicable fees will apply.



White Paper: Evaluating and Implementing Cubic Content into Linear Exhibit Space

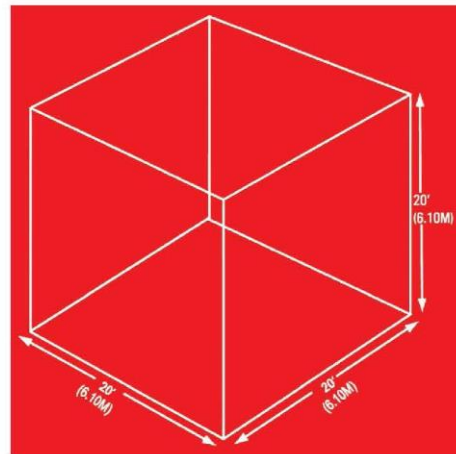
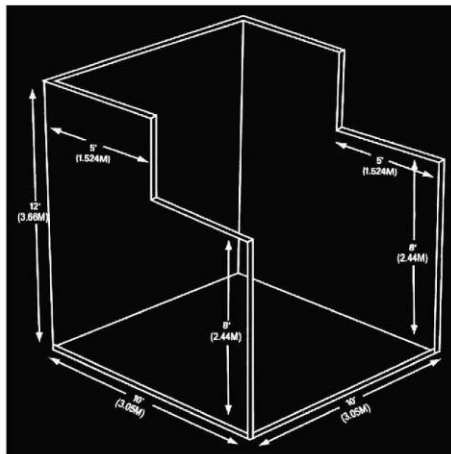
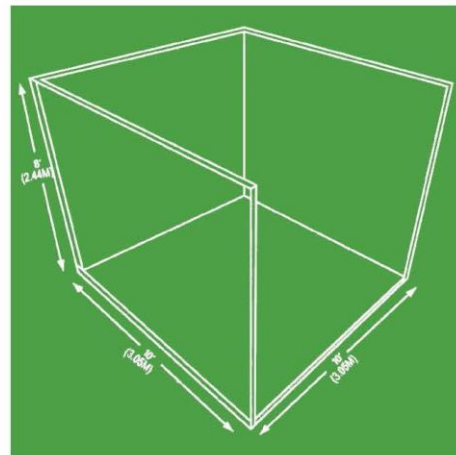
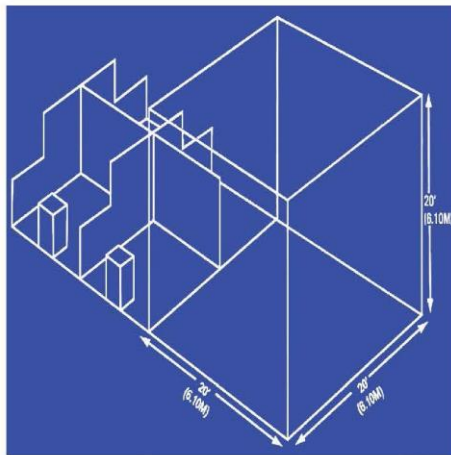

WHITE PAPER: EVALUATING AND IMPLEMENTING CUBIC CONTENT INTO LINEAR EXHIBIT SPACE

Table of Contents

Introduction.....	2
Research.....	2
Use of Cubic Content.....	2
International Exhibitions vs. US Exhibitions – Display Guidelines	3
Reasons to Consider.....	3
Key Responses from Exhibition Organizers Allowing Cubic Content (11 of 33 responses) – In Their Own Words.....	3
Exhibition Organizers Who Do Not Allow Cubic Content (22 of 33 responses) – In Their Own Words	4
Hardwall, Fabric, Portable, Modular, Table Top Displays, Pipe & Drape – Living Together.....	5
Floor Plan Layouts to Accommodate Linear Cubic Content Booths – Special Layouts	5
Cubic Content for Products	5
Equipment/Display Material: The following is an example of display rules for a specific type of item:.....	5
Perspective	5
Sample of Cubic Content Display Guidelines (Provided by Messe Frankfurt)	6

WHITE PAPER: EVALUATING AND IMPLEMENTING CUBIC CONTENT INTO LINEAR EXHIBIT SPACE

Introduction

IAEE presents the following white paper as an academic briefing without recommendation regarding the use of full cubic content for linear exhibit space and its potential impact on the exhibitions and events industry. As it pertains to exhibition booths, cubic content is a unit of measurement allowing display materials and products to occupy 100 percent of the exhibit space purchased, regardless of sightlines, up to a height established by the exhibition's rules.

It is the responsibility of the exhibition organizer to establish rules to best achieve the goals for its exhibition. Based on the nature of the exhibition, it is ultimately the choice of the exhibition organizer whether to allow use of full cubic content in linear exhibit space, or to observe the line-of-sight set-back rule. IAEE's publication, *Guidelines for Display Rules and Regulations* is intended to be viewed as guidelines, and not rules.

This white paper addresses the dynamics involved in the likelihood that as more international exhibitors participate in U.S.-based events, the expectations for cubic content availability will also increase. Thus the questions are:

- How can this new trend best be met, if at all?
- What methods might be employed to allow dual usage of both cubic content booths and line-of-sight booths?
- What are the advantages/disadvantages of doing so?

Further, many exhibitions and events today already allow for cubic content, primarily due to the nature of the industry sector it serves. It is prudent for the exhibition organizer considering cubic content for their exhibitions to review the concerns, advantages and disadvantages prior to putting cubic content guidelines into practice.

Research

IAEE requested feedback and input from its members from which 10 responses were received. Task force members then conducted telephone interviews with 35 show organizers whose organizations represent various industry sectors. Additional information was gathered through comments from the EDPA LinkedIn online discussion group. The responses are reflected in this document as to the advantages, disadvantages, international exhibitors, etc.

Use of Cubic Content

Under the current IAEE *Guidelines for Display Rules and Regulations*, cubic content, as it pertains to exhibitions and events, generally allows an exhibitor utilizing island space (a minimum of four 10' x 10' booths, open on four sides), to occupy 100 percent of the island space with both product and display materials. Regarding linear booths, it states "It is common at certain types of exhibitions to eliminate the line-of-sight requirement for Linear, End-Cap, and Peninsula Booths that back up to Linear Booths. This permits exhibitors to utilize the full cubic content of the booth." A Split Island Booth may also be allowed to utilize full cubic content of the booth when it backs up to another Split Island Booth.

The IAEE Guidelines for Display Rules and Regulations are not rules. Therefore some organizers have revised the Guidelines to fit their own needs as it pertains to cubic content and other guidelines. For instance, some heavy equipment exhibitions, for safety purposes, may require a setback of nine to twelve inches from the aisle line to prevent tripping. Others may require a 20 percent sightline of island booths.

For the purpose of this document we will restrict comments to construction and use of linear space. Many organizers today are permitting use of cubic content in linear booths because either their exhibitors find cubic content to be beneficial to their display, or because they want international exhibitors to feel welcome. It also reduces the need to police exhibits to enforce setback rules. The IAEE *Guidelines for Display Rules and Regulations* do not suggest cubic content should be implemented for linear booths; however cubic content in a linear booth is acceptable when the organizer has advantageous reasons to allow it. Prior to putting cubic content into practice, exhibition organizers must be proactive in communications with exhibitors, and understand the effect it will have on the exhibition. This document contains feedback from show organizers who allow use of cubic content in linear booths and those who do not. The intent is to assist a show organizer in making the best decision for their show.

WHITE PAPER: EVALUATING AND IMPLEMENTING CUBIC CONTENT INTO LINEAR EXHIBIT SPACE

International Exhibitions vs. US Exhibitions – Display Guidelines

Most European exhibitions and other countries allow the use of cubic content. Larry Kulchawik, senior vice president of 3D Exhibits, Inc., says, “Not all rules, styles, and customs are the same from country to country ... this is only one part of the country differences in trade show marketing, but a big one.”

Cubic Content for linear booths in the U.S. is not as popular as it is in other countries, but more and more U.S. organizers are finding it necessary to allow cubic content in linear booths for the sake of attracting and accommodating international exhibitors. Many U.S. exhibitions have government-sponsored international pavilions that typically are island spaces, back-to-back booths or booths facing each other with an aisle between. Depending on the type of space, these pavilions often are allowed to utilize full cubic content in the U.S.

International exhibitors occupying linear space sometimes bring in their own display house to help them conform to the U.S. display guidelines. The difference between U.S. display regulations and their country’s regulations, such as cubic content, square meters and square feet can be perplexing to a show’s new international exhibitor.

“Some clients want to capture the clientele in an enclosed stand and generally these clients have invitations in advance of the show so they have an appointment. Others prefer to enclose their stand to immerse the potential viewers in an experience. What better way than to take away the distraction of the other stands. Those that choose the open feel are trying to educate potential customers or get their corporate identity out there for everyone to see,” Mac Kieltyka, project manager of Creative Solutions Group.

Reasons to Consider

Aside from accommodating international exhibitors, or the belief that cubic content is more conducive to certain types of product displays or experiences, the fact is, today’s exhibitors want more return on their investment. Many exhibitors feel they should be able to utilize all the space they have paid for without a five-foot setback rule. Exhibitors want to display their products in a structure or setting that is best suited toward maximizing their investment. Ultimately it is the show organizer who will decide whether cubic content is a practical display regulation.

Key Responses from Exhibition Organizers Allowing Cubic Content (11 of 33 responses) – In Their Own Words

“With the exception of one or two shows, all are cubic content. We have utilized cubic content for years and feel it gives our customers more value for their money by allowing them to use more of their space. The one or two shows we do not use cubic content on, we rarely get any push back and those shows do have an international presence. What feedback we do get (which is minimal) is typically centered on obstructions from a neighboring booth. These objections often come from those who have not read our exhibitor manual where cubic content is prominently addressed.”

“We have already implemented it for all nine shows we run in North America. Linear Booth Use of Space: Shows allow exhibitors full “Cubic Content” use of the exhibit space. Therefore, you are allowed to place displays or materials at the full eight foot (2.44m) height throughout the entire width and depth of your exhibit space. Perimeter Booth Dimensions and Use of Space: All guidelines for Linear Booths apply to Perimeter Booths except that the maximum back wall height is 12ft (3.66m). There were a few complaints initially, but they were a minority and have now stopped. We make sure to explain the rules clearly to new exhibitors and to remind everyone frequently. We implemented this because it made it more consistent for our international exhibitors from around the world, and eliminated the majority of our set-up issues onsite (which are mostly due to sightline issues).”

“Our exhibition allows for the use of the cubic content of exhibit spaces. The feedback has been overwhelmingly positive. Most companies exhibit in some international shows. They appreciate the consistency of having the same rules and also see the common sense approach to allow exhibitors to use all their space. And, since it is fully implemented, it is fair for all. We allow cubic content in all areas.”

WHITE PAPER: EVALUATING AND IMPLEMENTING CUBIC CONTENT INTO LINEAR EXHIBIT SPACE

"We do have an abbreviated cubic content rule for islands and split islands. The entire cubic content of the space may be used up to the maximum allowable height; however exhibitors must follow the line-of-sight guidelines (20 percent) listed above. The line-of-sight guideline referenced above states: All booths regardless of size or type should be designed in such a way so as to eliminate line-of-sight obstructions from one exhibit to the next. A solid wall or banner between an island or split-island booth and a row of linear booths (particularly along the perimeter) is inappropriate. This is particularly important along shared walls and borders between linear and split-island exhibits. If you are planning a hardwall installation that could obstruct the view to neighbors' booths, a booth variance form and schematic must be submitted for review. **NEW** – All island booths regardless of size should allow 20 percent of visibility on all sides excluding the shared back wall. Examples: 20' x 20' Island: each side of the booth must have visibility for a minimum of 4'. 30' x 40' Island: the 30' sides of the booth must allow visibility for a minimum of 6'; the 40' sides of booth must allow visibility of 8'. Exhibitors may use Plexiglas or similar material to create a wall that will allow for line-of-sight from one booth to the next.

The linear 10' x 10's have a harder time understanding that they must follow the standard IAEE rules allowing for no product or displays over 4' tall in the front half of the booth. We have had this guideline in place for about three years now, but have always allowed them to receive a variance if their theaters, meeting rooms, etc., did not allow for this amount of line-of-sight. However, at this time we are telling exhibitors that we will be enforcing the rule for the 2012 show. Our exhibitor advisory committee requested that we begin enforcing the rule for next year."

"Exhibitors are to show respect for fellow exhibitors and fire marshal rules must be met – island exhibits and linear."

"Yes, exhibits can be closed on three sides for linear booths, totally closed in for islands."

"We approve on a request-only basis. Show is less than 10 percent cubic content exhibits."

"We will allow cubic content for booths that are against an outside wall that do not have adjacent booths/neighbors."

Exhibition Organizers Who Do Not Allow Cubic Content (22 of 33 responses) – In Their Own Words

"We do not like the reduced sightlines that this would create."

"We feel it is important to protect sightlines. We spend time communicating with them (international exhibitors) to try to set expectations before they arrive for the show."

"Most overseas exhibitors want to comply with line-of-sight rules when they exhibit in the U.S; however, some request cubic content and those requests are granted. No complaints from neighbors."

"While the cubic approach to booth content may eliminate some issues and policing, we believe in the line-of-sight good neighbor policy. If exhibitors want to use cubic content for their booth, they can purchase an island."

"Unfair to our small exhibitors that depend on a fair sightline into their booth."

Note: All other exhibition organizers interviewed said they use the line-of-sight in the *IAEE Guidelines for Display Rules and Regulations*.

WHITE PAPER: EVALUATING AND IMPLEMENTING CUBIC CONTENT INTO LINEAR EXHIBIT SPACE

Hardwall, Fabric, Portable, Modular, Table Top Displays, Pipe & Drape – Living Together

There are many different types of displays used in exhibitions. If the organizer chooses to allow cubic content in linear booths, the organizer needs to be aware of the responsibility to communicate the rules clearly to all exhibitors so there are no surprises on site. A portable exhibit may only extend five feet out from the backwall but its neighbor may have hardwall at eight-foot height out to the aisle line. The portable exhibit must be aware the sightline will be impacted and the hardwall exhibitor must be sure the backsides of the panels are finished. This is true with all exhibits in a linear space cubic content exhibition. If the rules allow for cubic content in linear spaces, then it is a fair environment for all to choose how they wish to use that space; but communication is key to a smooth operation.

It is rare to expect a U.S. exhibition or its general service contractor, to provide hardwall for all exhibitors; however, exhibitions using all hardwall do exist in the U.S.

Floor Plan Layouts to Accommodate Linear Cubic Content Booths – Special Layouts

None of the show organizers interviewed indicated a need for a split floor plan, i.e., certain areas of the floor are designated for linear cubic content booths.

Cubic Content for Products

Some exhibition organizers allow products to exceed the four-foot high rule five feet in from the aisle line. Others do not and strictly enforce the sightline setback. The types of products displayed may determine whether an organizer chooses to permit products only (not booth structure) to occupy the cubic content of a linear booth. However, for example, if the product is banner stands that are eight feet or 10 feet tall, a row of banner stands at the aisle line may be very intrusive to a neighbor. On the other hand, a piece of machinery that is six feet tall may not cause a major problem. Exceptions may also depend upon the size of a booth such as 10' by 20' versus 10' by 10'. Under certain circumstances, an organizer may prefer to make the exception a variance, subject to show management review and approval. This option provides the organizer more control if product is an exception to the set-back guidelines.

Equipment/Display Material: The following is an example of display rules for a specific type of item:

- SPECIAL PROVISIONS: Pedestals, tables, racks, shelves, risers and similar display equipment may not exceed 42" in height when positioned more than 5' from the back wall of a single-aisle exhibit booth space or the center line of a three-aisle exhibit booth space, unless the same company occupies 8' of exhibit booth space on both sides of the unit or units. The maximum height for such items under these circumstances, including the product being displayed, is 66". Free-standing units, including those intended to be the focal point in an exhibit, may not exceed 42" in height when placed more than 5' from the back wall of the exhibit booth space unless the same company occupies 8' of exhibit booth space on both sides of the unit or units. The maximum dimensions for such items under these conditions are 8' high x 32" wide x 32" deep.

Perspective

It is inevitable that exhibition organizers will have varying thoughts and opinions about allowing exhibitors to have full use of the cubic content space within their linear booth. Just as there are many different opinions as to whether end cap booths are permissible in floor plan layouts due to the somewhat difficult situations they often times create, the exhibition organizer must make the determination as to what is best for their exhibition.

It is often wise to consult with an exhibition's Exhibits Advisory Board. Alternatively, an organizer may consider conducting a focus group of the exhibition's exhibitors to determine their interest and gain their feedback.

A linear space exhibitor utilizing cubic content for the first time may also experience some higher costs. If they bring a hardwall display that reaches 8' high for three sides of their exhibit, when in the past they utilized a fabric display, obviously their labor, shipping and drayage costs will be higher. However, that is the decision of the exhibitor if the exhibition organizer is allowing cubic content for linear displays and the exhibitor chooses to take advantage of the space in this fashion.

WHITE PAPER: EVALUATING AND IMPLEMENTING CUBIC CONTENT INTO LINEAR EXHIBIT SPACE

Sample of Cubic Content Display Guidelines (Provided by Messe Frankfurt)

Linear Booth

Linear Booths have only one side open to an aisle and are generally arranged in a series along a straight line. They are also called “in-line” booths. Floor covering is required in all rented space.

Dimensions

For purposes of consistency and ease of layout and/or reconfiguration, floor plan design in increments of 10ft (3.05m) has become the de facto standard in the United States. Therefore, unless constricted by space or other limitations, Linear Booths are most commonly 10ft (3.05m) wide and 10ft (3.05m) deep, i.e. 10ft by 10ft (3.05m by 3.05m), with a maximum back wall height limitation of 8ft (2.44m).

Use of Space

Messe Frankfurt Shows allow exhibitors full “Cubic Content” use of the exhibit space. Therefore, you are allowed to place displays or materials at the full 8 ft. (2.44m) height throughout the entire width and depth of your exhibit space.

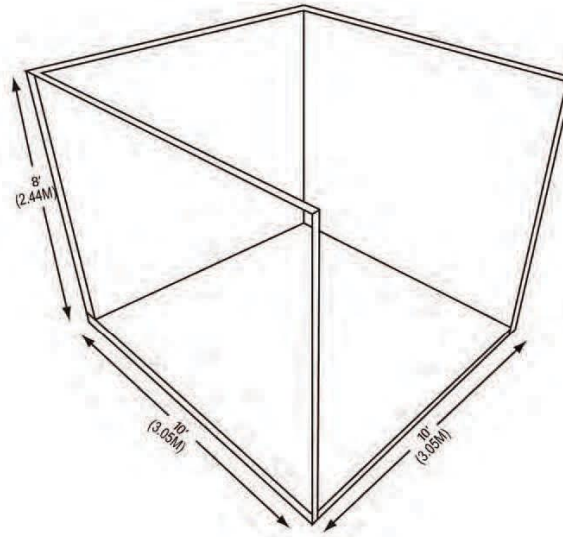

LINEAR BOOTH (10' X 10') (3.05m x 3.05m)

Corner Booth

A Corner Booth is a Linear Booth exposed to aisles on two sides. All other guidelines for Linear Booths apply.

WHITE PAPER: EVALUATING AND IMPLEMENTING CUBIC CONTENT INTO LINEAR EXHIBIT SPACE

Sample of Cubic Content Display Guidelines (Provided by Messe Frankfurt)

Perimeter Booth

A Perimeter Booth is a Linear Booth that backs to an outside wall of the exhibit facility rather than to another exhibit. Floor covering is required in all rented space.

Dimensions and Use of Space

All guidelines for Linear Booths apply to Perimeter Booths except that the maximum back wall height is 12ft (3.66m).

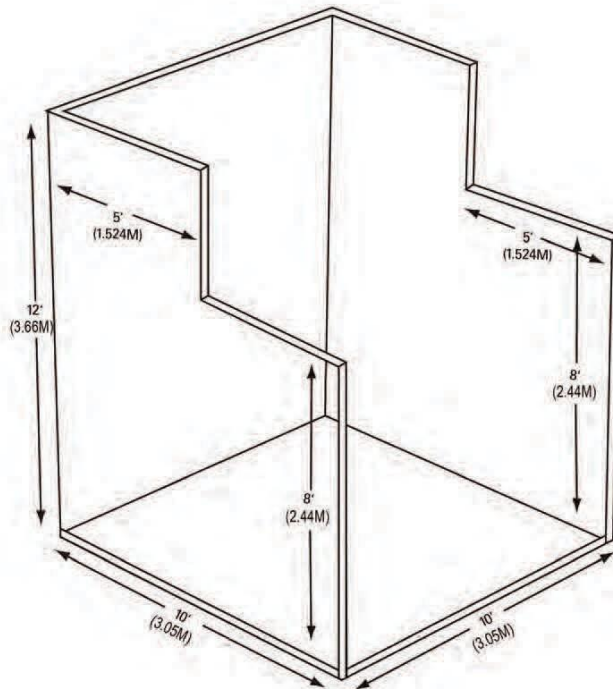

PERIMETER BOOTH (10' X 10') (3.05m x 3.05m)

WHITE PAPER: EVALUATING AND IMPLEMENTING CUBIC CONTENT INTO LINEAR EXHIBIT SPACE

Sample of Cubic Content Display Guidelines (Provided by Messe Frankfurt)

Peninsula Booth

A Peninsula Booth is exposed to aisles on three (3) sides and is a minimum of 20' x 20' (6.10m) in size. Floor covering is required in all rented space.

Dimensions

A Peninsula Booth is usually 20' x 20' (6.10m x 6.10m) or larger. Twenty feet (20') (6.10m), including hanging signage, is the maximum height allowed throughout the booth space. The connecting wall between the peninsula booth and any neighbors must be "finished off" (clean and presentable to visitors) on the side facing the connecting neighbors.

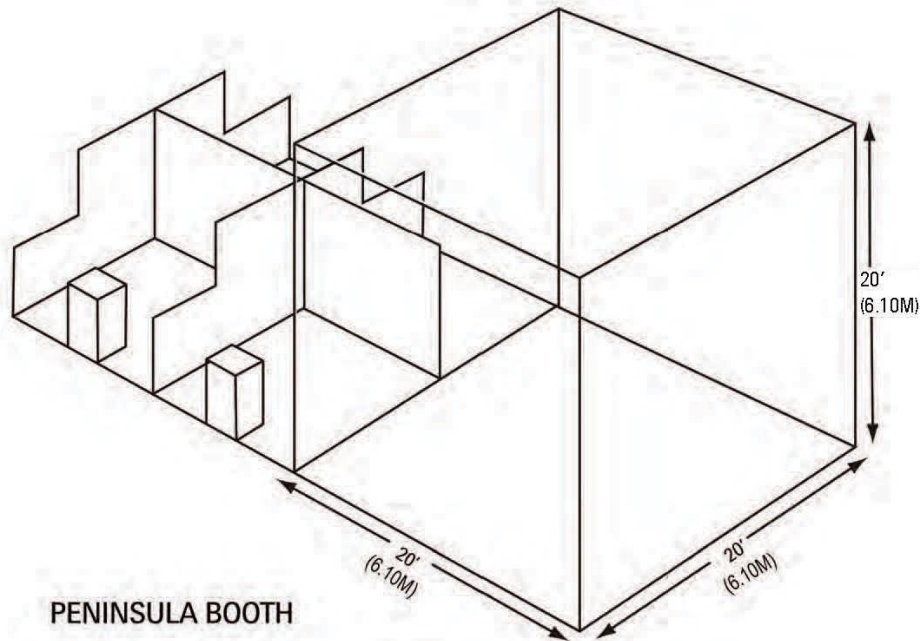

WHITE PAPER: EVALUATING AND IMPLEMENTING CUBIC CONTENT INTO LINEAR EXHIBIT SPACE

Sample of Cubic Content Display Guidelines (Provided by Messe Frankfurt)

Island Booth

An Island Booth is any size booth exposed to aisles on all four sides. Floor covering is required in all rented space.

Dimensions

An Island Booth is typically 20' x 20' (6.10m x 6.10m) or larger.

Use of Space

The entire cubic content of the space may be used up to the maximum allowable height of twenty feet (20') (6.10m), including any hanging signage.

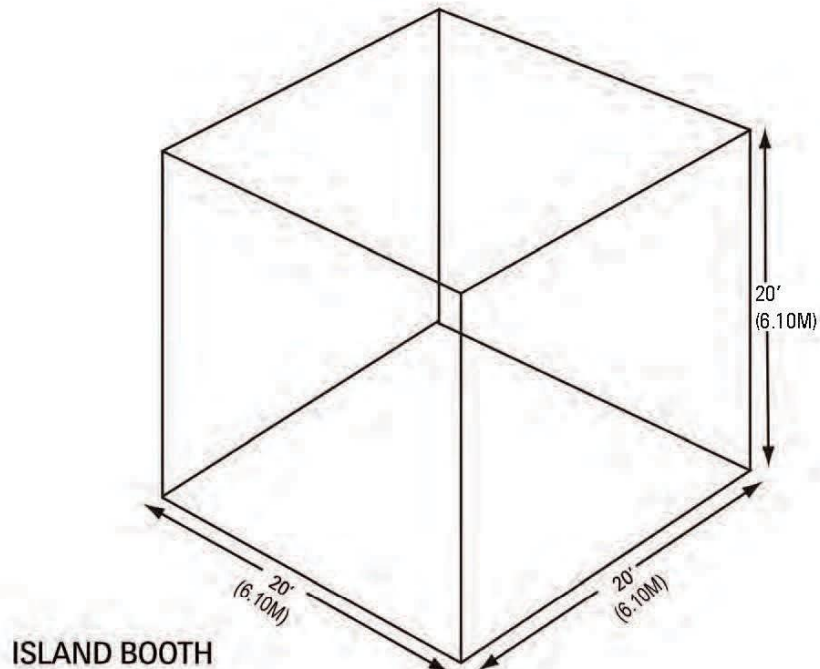

WHITE PAPER: EVALUATING AND IMPLEMENTING CUBIC CONTENT INTO LINEAR EXHIBIT SPACE

IAEE appreciates the efforts of the Cubic Content Task Force in developing this White Paper:

Carol Fojtik, CEM, Chair
Robert C. Brice
Thomas C. Corcoran
Kevin Johnstone
Martin Moggre, CEM
Pamela Kay Pietrok
Paul Prince, CEM
Chuck Schwartz, CEM
Barry Siskind
Julie Anderson, CEM, CAE, Staff Liaison
Terri Phillips, Staff Assistant

Additional appreciation goes to the following organizations that contributed relevant content for this white paper.

American Society of Mechanical Engineers
Association of Equipment Manufacturers
Corcoran Expositions
Distribution Solutions Conference
ExpoNation LLC
Home Builders Show
IMN Solutions
InfoComm
International Association of Fairs and Expositions
Messe Frankfurt
National Association of Broadcasters
National Restaurant Association
Reed Exhibitions

IAEE EXTENDS A SPECIAL THANK YOU TO THE FOLLOWING VOLUNTEERS FOR THEIR INPUT:

Russell Wingard, CEM
Vice President, Client
Solutions Freeman

**Frank
Sheridan**
Principal

2023 MATSO

John Rozum, Chairperson
Senior Director, Ag & Utility Exhibitions and
Events Association of Equipment
Manufacturers

Lisa Malikow, Vice Chairperson
Senior Vice President, Event Operations &
Programming National Restaurant Association
Show/Winsight Media

**Mark Bogdansky, Immediate Past
Chairperson**
Vice President, Meetings &
Events Auto Care
Association

Melodie Anderson, CEM, DES
Director of Meeting and Exhibit
Experiences Institute of Food
Technologists

Kate Hawley, CEM
Senior Manager, WEFTEC
Exhibition Sales Water Environment
Federation

Nath Morris, CEM
President, Expo
U.S. Poultry & Egg Association

Merideth Newman, CEM
Director, Expositions
The Association for Packaging and
Processing Technologies – PMMI

Gary Thuro
Chief Marketing & Sales
Officer RE+ Events

Ellen Tucker, CAE, MAS
Vice President of Revenue & Expositions
PPAI: Promotional Products Association
International

Jess Tyler, CEM
Chief Revenue and Experience Officer
at MJBiz A division of Emerald X, LLC